



# PARKER CALZONI Radial Piston Motor Type MR, MRE



RCOe 1806/09.05

CALZONI

CONTENTS	PAG.
TABLE OF CONTENTS	2
GENERAL CHARACTERISTICS	3
FUNCTIONAL DESCRIPTION	4
TECHNICAL DATA	5
FLUID SELECTION	6
FLUSHING PROCEDURE	7
OPERATING DIAGRAM MOTOR TYPE MR 33 MR 57 MR 73	8
OPERATING DIAGRAM MOTOR TYPE MR 93 MR 110 MR 125	9
OPERATING DIAGRAM MOTOR TYPE MR 160 MR 190 MR 200	10
OPERATING DIAGRAM MOTOR TYPE MR 250 MR 300 MRE 330	11
OPERATING DIAGRAM MOTOR TYPE MR 350 MR 450 MRE 500	12
OPERATING DIAGRAM MOTOR TYPE MR 600 MR 700 MRE 800	13
OPERATING DIAGRAM MOTOR TYPE MR 1100 MRE 1400 MR 1600	14
OPERATING DIAGRAM MOTOR TYPE MR 1800 MRE 2100 MR 2400	15
OPERATING DIAGRAM MOTOR TYPE MR 2800 MRE 3100 MR 3600	16
OPERATING DIAGRAM MOTOR TYPE MR 4500 MRE 5400 MR 6500	17
OPERATING DIAGRAM MOTOR TYPE MR 7000 MRE 8200	18
OPERATINGDIAGRAM(RUNNINGPRESSUREDIFFERENCEATNOLOAD)	19-20
OPERATINGDIAGRAM(MOTOR/PUMP:BOOSTPRESSURE)	20-21
RADIAL LOAD	22
BEARING LIFE	23
MOTOR DIMENSIONS	24-25
SHAFT END DIMENSIONS	26-27
COMPONENTS FOR SPEED CONTROL	28-29
PIPE CONNECTION FLANGES	30
COUPLINGS - KEY ADAPTERS	31
HOLDING BRAKE - UNIT DIMENSIONS - TECHNICAL DATA	32-33
INSTALLATION NOTES	34
ORDERING CODE	35
SALES AND SERVICE LOCATIONS WORLDWIDE	36

## GENERAL CHARACTERISTICS

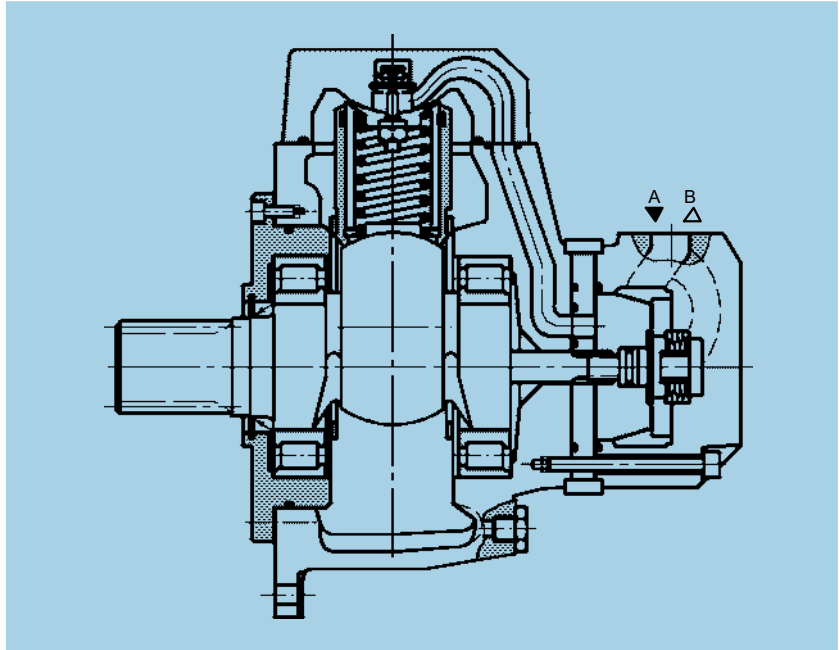

<b>CONSTRUCTION</b>	Fixed displacement radial piston motor
<b>TYPE</b>	MR ; MRE
<b>MOUNTING</b>	Front flange mounting
<b>CONNECTION</b>	Connection flange
<b>MOUNTING POSITION</b>	Any (please note the installation notes on page 34)
<b>BEARING LIFE, RADIAL LOAD</b>	See page 22 and 23
<b>DIRECTION OF ROTATION</b>	Clockwise, anti-clockwise - reversible
<b>FLUID</b>	HLP mineral oils to DIN 51 524 part 2; Fluid type HFB, HFC and Bio-fluids on enquiry. FPM seals are required with phosphorous acid-Ester (HFD)
<b>FLUID TEMPERATURE RANGE</b>	$t$ °C – 30° to + 80°
<b>VISCOSITY RANGE</b> <sup>1)</sup>	$\nu$ mm <sup>2</sup> /s 18 to 1000: Recommended operating range 30 to 50 (see fluid selection on page 6)
<b>FLUID CLEANLINESS</b>	Maximum permissible degree of contamination of fluid NAS 1638 Class 9. We therefore recommend a filter with a minimum retention rate of $\beta_{10} > 75$ . To ensure a long life we recommend class 8 to NAS 1638. This can be achieved with a filter, with a minimum retention rate of $\beta_5 > 100$ .

1) For different valves of viscosity please contact PARKER Calzoni

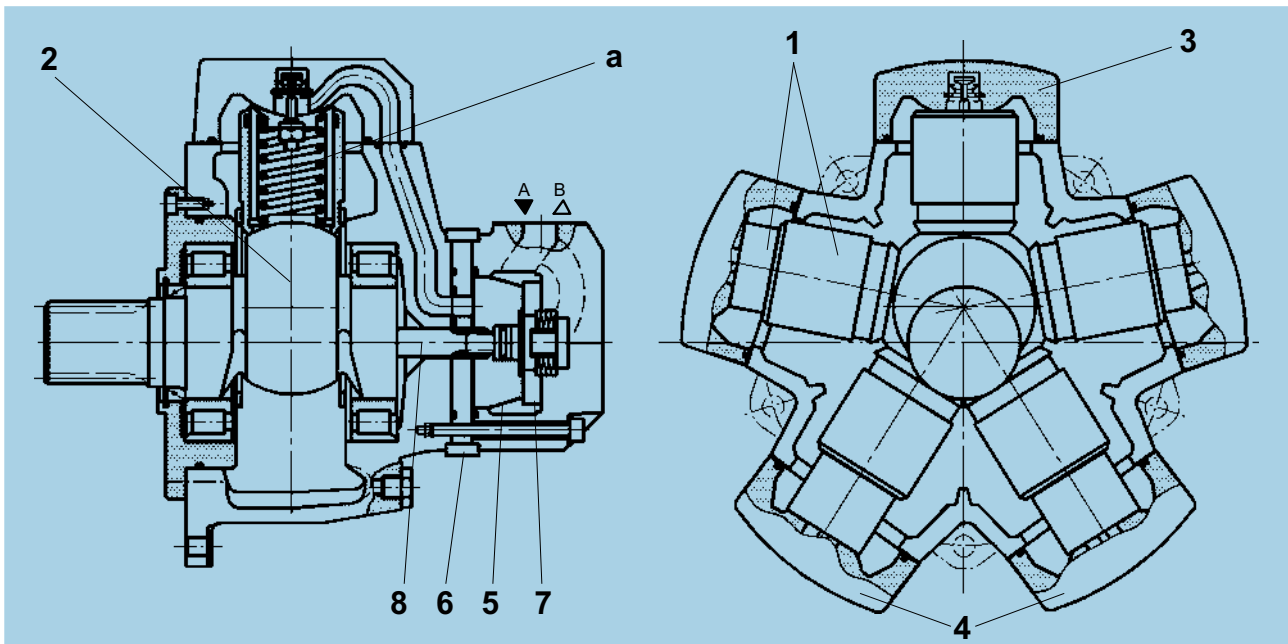

**FUNCTIONAL DESCRIPTION**

The outstanding performance of this motor is the result of an original and patented design. The principle is to transmit the effort from the stator to the rotating shaft (2) by means of a pressurized column of oil (a) instead of the more common connecting rods, pistons, pads and pins.

This oil column is contained by a telescopic cylinder (1) with a mechanical connection at the lips at each end which seal against the spherical surfaces of the cylinder-heads (3) and the spherical surface of the rotating shaft (4).

These lips retain their circular cross section when stressed by the pressure so there is no alteration in the sealing geometry. The particular selection of materials and optimisation of design has minimized both the friction and the leakage.

Another advantage of this design stems from the elimination of any connecting rods, the cylinder can only expand and retract linearly so there are no transverse components of the thrust. This means no oval wear on the moving parts and no side forces on the cylinder joints.

A consequence of this novel design is a significant reduction in weight and overall size compared with other motors of the same capacity.

**TIMING SYSTEM**

The timing system is realized by means of a rotary valve (5) driven by the rotary valve driving shaft (8) that it is connected to the rotating shaft.

The rotary valve rotates between the rotary valve plate (6) and the reaction ring (7) which are fixed with the motor's housing. This timing system is also of a patented design being pressure balanced and self compensating for thermal expansion.

**EFFICIENCY**

The advantages of this type of valve coupled with a revolutionary cylinder arrangement produce a motor with extremely high values of mechanical and volumetric efficiency. The torque output is smooth even at very low speed and the motor gives a high performance starting under load.

TECHINICAL DATA - MOTOR TYPE MR - MRE

Size Motor version	Displacement	Moment inertia of rotating parts	Theoretical specific torque	Min. start. torque / Theoretical torque	Maximum Pressure					Speed range		Maximum output power		Weight	
					input			A+B *	Drain	flushing		flushing			
					cont.	int.	peak			without	with	without	with		
					V	J		%	p	p	p	p	p		n
cm <sup>3</sup>	kg cm <sup>2</sup>	Nm/bar		bar	bar	bar	bar	bar	rpm	rpm	kW	kW	kg		
<b>M R</b>	<b>33</b>	32,1	4,32	0,50	90	250	300	420	400	5 (15 bar with "F1" shaft seal)	1-1400	1-1400	6,6	10	30
	<b>57</b>	56,4	4,76	0,90	90						1-1300	1-1300	11	17	30
	<b>73</b>	72,6	14,03	1,20	90						1-1200	1-1200	15	20	38
	<b>93</b>	92,6	15,11	1,50	90						1-1150	1-1150	17	25	38
	<b>110</b>	109,0	16,19	1,70	90						1-1100	1-1100	18	28	38
	<b>125</b>	124,7	56,88	2,00	90						1-900	1-900	17	25	46
	<b>160</b>	159,7	57,50	2,54	90						1-900	1-900	20	30	46
	<b>190</b>	191,6	58,20	3,05	90						1-850	1-850	24	36	46
	<b>200</b>	199,2	57,15	3,20	90						1-800	1-800	25	38	50
	<b>250</b>	250,9	60,80	4,00	90						1-800	1-800	32	48	50
	<b>300</b>	304,1	65,43	4,80	90						1-750	1-750	35	53	50
	<b>350</b>	349,5	225,90	5,57	90						1-640	1-640	41	62	77
	<b>450</b>	451,6	229,80	7,20	90						1-600	1-600	46	75	77
	<b>600</b>	607,9	265,07	9,70	90						1-520	1-520	56	84	97
	<b>700</b>	706,9	358,40	11,30	90						1-500	1-500	65	97	97
	<b>1100</b>	1125,8	451,50	17,90	90						0,5-330	0,5-330	77	119	140
	<b>1600</b>	1598,4	666,43	25,40	90						0,5-260	0,5-260	96	144	209
	<b>1800</b>	1809,6	854,10	28,80	90						0,5-250	0,5-250	103	153	209
	<b>2400</b>	2393,0	2835,40	38,10	90						0,5-220	0,5-220	120	183	322
	<b>2800</b>	2792,0	2975,70	44,50	90						0,5-215	0,5-215	127	194	322
<b>3600</b>	3636,8	4851,40	57,90	90	0,5-150	0,5-180	123	185	505						
<b>4500</b>	4502,7	5015,10	71,70	91	0,5-130	0,5-170	140	210	505						
<b>6500</b>	6460,5	11376,6	103,57	91	0,5-110	0,5-130	165	240	797						
<b>7000</b>	6967,2	11376,6	111,39	91	0,5-100	0,5-130	170	250	797						
<b>M R E</b>	<b>330</b>	332,4	65,50	5,30	90	210	250	350	400	5 (15 bar with "F1" shaft seal)	1-750	1-750	32	49	50
	<b>500</b>	497,9	229,80	7,93	90						1-600	1-600	46	70	77
	<b>800</b>	804,2	358,40	12,81	90						1-450	1-450	65	93	97
	<b>1400</b>	1369,5	451,50	21,80	92						0,5-280	0,5-280	77	102	145
	<b>2100</b>	2091,2	854,10	33,30	91						0,5-250	0,5-250	100	148	221
	<b>3100</b>	3103,7	2975,70	49,40	91						0,5-215	0,5-215	125	190	326
	<b>5400</b>	5401,2	5015,10	86,01	92						0,5-120	0,5-160	140	210	509
	<b>8200</b>	8226,4	11376,6	130,90	92						0,5-90	0,5-120	170	250	807

LARGER DISPLACEMENTS ARE AVAILABLE IN THE MRT - MRTE - MRTF MOTOR SERIES

(\*) Please consult PARKER Calzoni

**EXAMPLE:** At a certain ambient temperature, the operating temperature in the circuit is 50°C. In the optimum operating viscosity range ( $v_{rec}$ : shaded section), this corresponds to viscosity grades VG 46 or VG 68; VG 68 should be selected.

**IMPORTANT:** The drain oil temperature is influenced by pressure and speed and is usually higher than the circuit temperature or the tank temperature. At no point in the system, however, may the temperature be higher than 80°C.

If the optimum conditions cannot be met due to the extreme operating parameters or high ambient temperature, we always recommend flushing the motor case in order to operate within the viscosity limits.

Should it be absolutely necessary to use a viscosity beyond the recommended range, you should first contact PARKER Calzoni for confirmation.

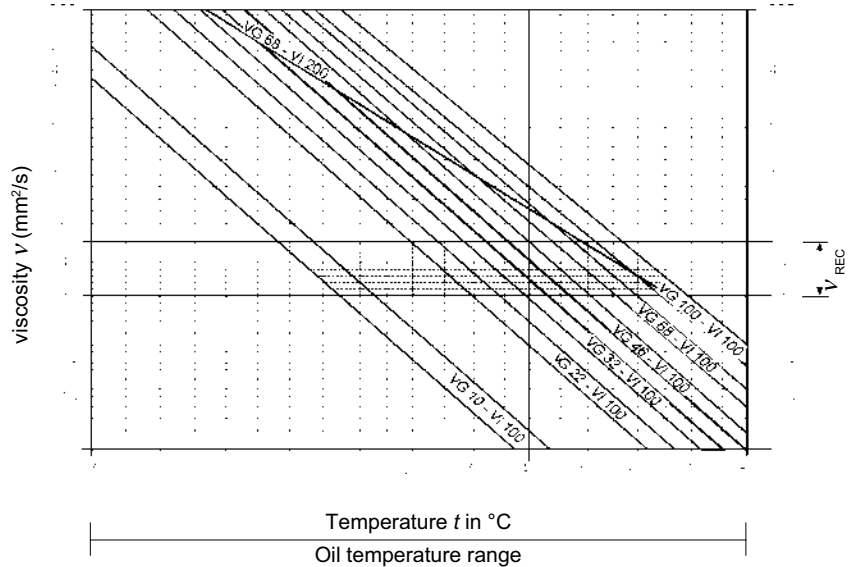

**GENERAL NOTES**

More detailed information regarding the choice of the fluid can be requested to PARKER Calzoni. Further notes on installation and commissioning can be found on page 34 of this data sheet. When operating with HF pressure fluids or bio-degradable pressure fluids possible limitations of the technical data must be taken into consideration, please see information sheet TCS 85, or consult PARKER Calzoni.

**OPERATING VISCOSITY RANGE**

The viscosity, quality and cleanliness of operating fluids are decisive factors in determining the reliability, performance and life-time of an hydraulic component. The maximum life-time and performance are achieved within the recommended viscosity range. For applications that go beyond this range, we recommend to contact PARKER Calzoni.

$$v_{rec} = \text{recommended operating viscosity } 30 \dots 50 \text{ mm}^2/\text{s}$$

This viscosity refers to the temperature of the fluid entering the motor, and at the same time to the temperature inside the motor housing (case temperature). We recommend to select the viscosity of the fluid based on the maximum operating temperature, to remain within the recommended viscosity range. To reach the value of maximum continuous power the operating viscosity should be within the recommended viscosity range of 30 - 50 cSt.

**LIMITS OF VISCOSITY RANGE**

For limit conditions the following is valid:

$$v_{min.abs.} = 10 \text{ mm}^2/\text{s in emergency, short term}$$

$$v_{min.} = 18 \text{ mm}^2/\text{s for continuous operation at reduced performances}$$

$$v_{max.} = 1000 \text{ mm}^2/\text{s short term upon cold start}$$

**CHOOSING THE TYPE OF FLUID ACCORDING TO THE OPERATING TEMPERATURE**

The operating temperature of the motor is defined as the greater temperature between that of the incoming fluid and that of the fluid inside the motor housing (case temperature). We recommend that you choose the viscosity of the fluid based on the maximum operating temperature, to remain within the recommended viscosity range (see diagram). We recommend that the higher viscosity grade must be selected in each case.

**FILTRATION**

The motor life also depends on the fluid filtration. At least it must correspond to one of the following cleanliness.

class 9	according to NAS 1638
class 6	according to SAE, ASTM, AIA
class 18/15	according to ISO/DIS 4406

In order to assure a longer life a cleanliness class 8 to NAS 1638 is recommended, achieved with a filter of  $\beta_3=100$ . In case the above mentioned classes can not be achieved, please consult us.

**CASE DRAIN PRESSURE**

The lower the speed and the case drain pressure, the longer the life of the shaft seal. The maximum permissible housing pressure is

$$p_{max} = 5 \text{ bar}$$

If the case drain pressure is higher than 5 bar it is possible to use a special 15 bar shaft seal (see page 35, Seals, Code "F1").

**"FPM" SEALS**

In case of operating conditions with high oil temperature or high ambient temperature, we recommend to use "FPM" seals (see page 35, Seals, Code "V1"). These "FPM" seals should be used with HFD fluids.

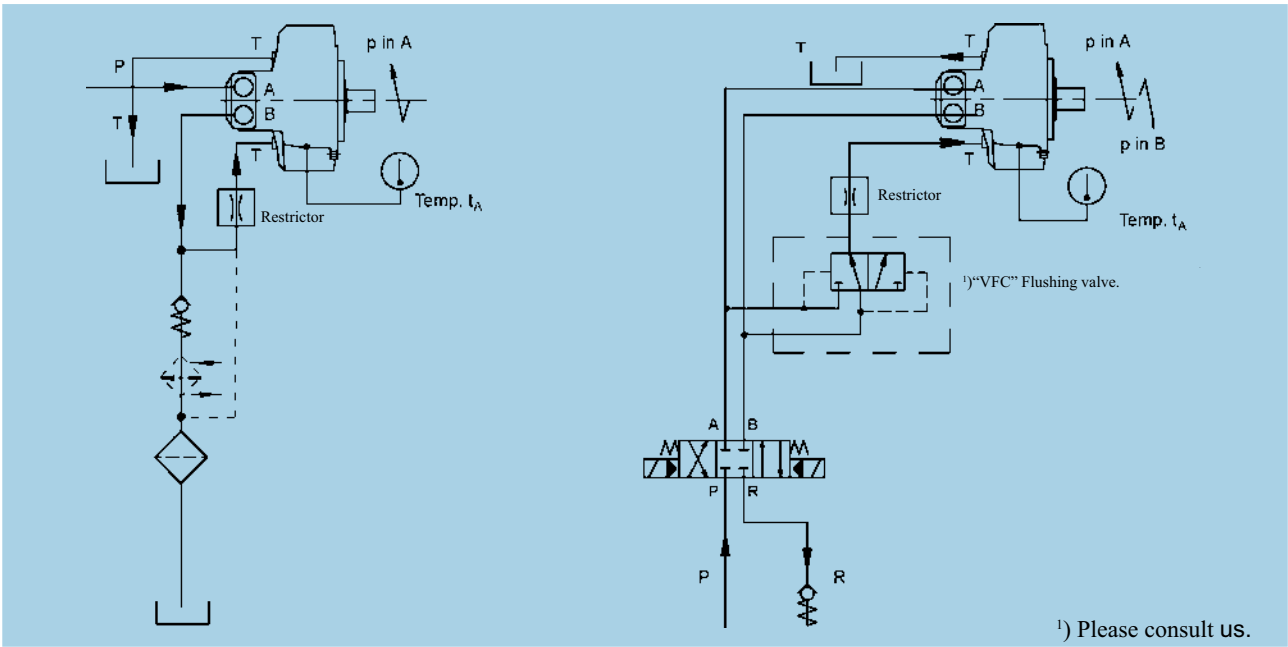

<sup>1)</sup> Please consult us.

FLUSHING CIRCUIT  
(MONO-DIRECTIONAL ROTATION)

FLUSHING CIRCUIT  
(BI-DIRECTIONAL ROTATION)

**FLUSHING**

The motor case must be flushed when the continuous operating performances of the motor are inside the "Continuous operating area with flushing" (see Operating Diagram from page 8 to page 18), in order to assure the minimum oil viscosity inside the motor case of 30 mm<sup>2</sup>/s (see page 6 - Fluid Selection). The flushing can be necessary also when the operating performances are outside the "Continuous operating area with flushing", but the system is not able to assure the minimum viscosity conditions requested by the motor as specified at page 6.

**NOTE1:**

The oil temperature inside the motor case is obtainable by adding 3°C to the motor surface temperature ( $t_A$ , see figures).

**NOTE2:**

With the standard shaft seal the maximum drain case pressure is 5 bar. For the selection of the restrictor, please consult us.

**FLOW**

TYPE	MOTOR VERSION	FLUSHING FLOW
MR	33, 57, 73, 93, 110	Q = 5 l/min
MR - MRE	125, 160, 190, 200, 250, 300, 330	Q = 6 l/min
MR - MRE	350, 450, 500	Q = 8 l/min
MR - MRE	600, 700, 800, 1100, 1400	Q = 10 l/min
MR - MRE	1600, 1800, 2100	Q = 15 l/min
MR - MRE	2400, 2800, 3100, 3600, 4500, 5400, 6500, 7000, 8200	Q = 20 l/min



OPERATING DIAGRAM

(average values) measured at  $V = 36 \text{ mm}^2/\text{s}$ ;  $t = 45^\circ \text{ C}$ ;  $p_{\text{outlet}} = 0 \text{ bar}$

- 1 Output power
- 2 Intermittent operating area
- 3 Continuous operating area with flushing
- 4 Continuous operating area
- 5 Inlet pressure
- $\eta_t$  Total efficiency
- $\eta_v$  Volumeter efficiency

MR 33

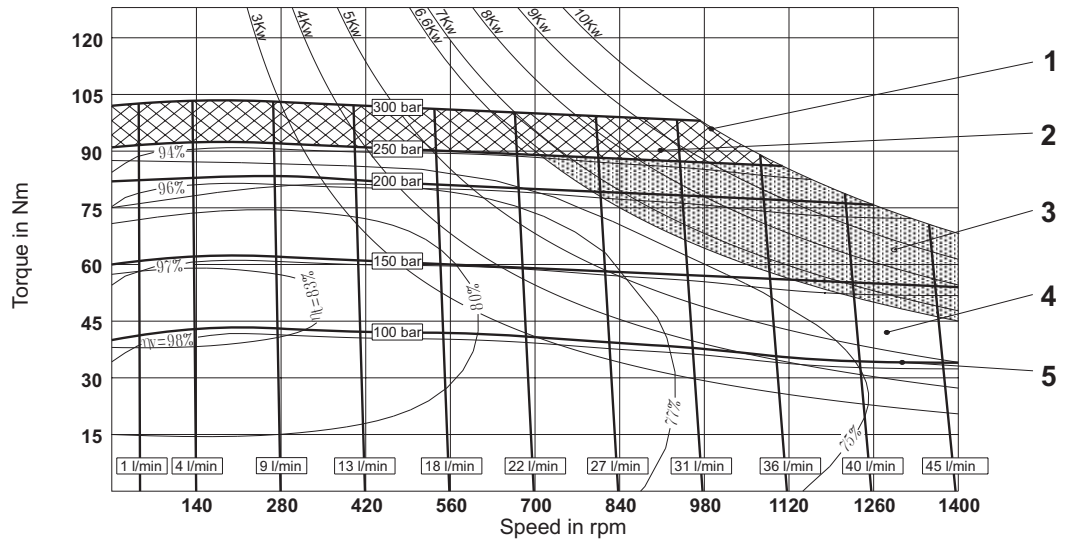

MR 57

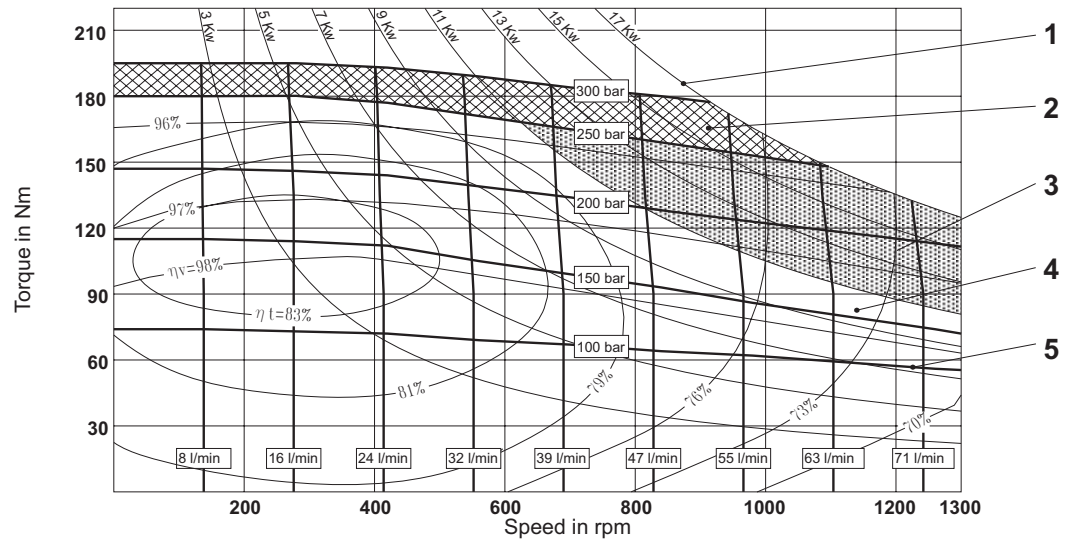

MR 73

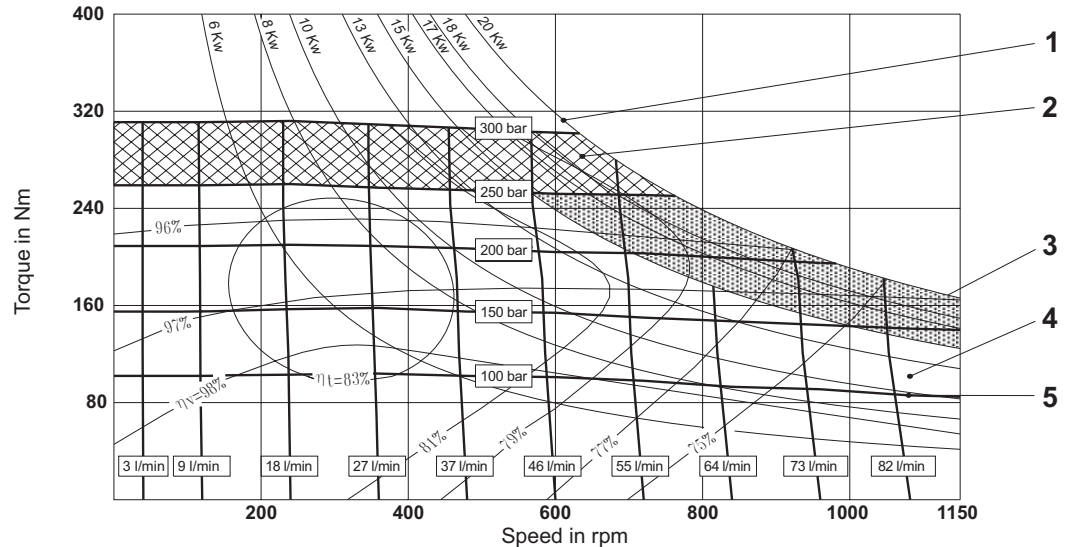



OPERATING DIAGRAM

(average values) measured at  $V = 36 \text{ mm}^2/\text{s}$ ;  $t = 45^\circ \text{ C}$ ;  $p_{\text{outlet}} = 0 \text{ bar}$

- 1 Output power
- 2 Intermittent operating area
- 3 Continuous operating area with flushing
- 4 Continuous operating area
- 5 Inlet pressure
- $\eta_t$  Total efficiency
- $\eta_v$  Volumeter efficiency

MR 93

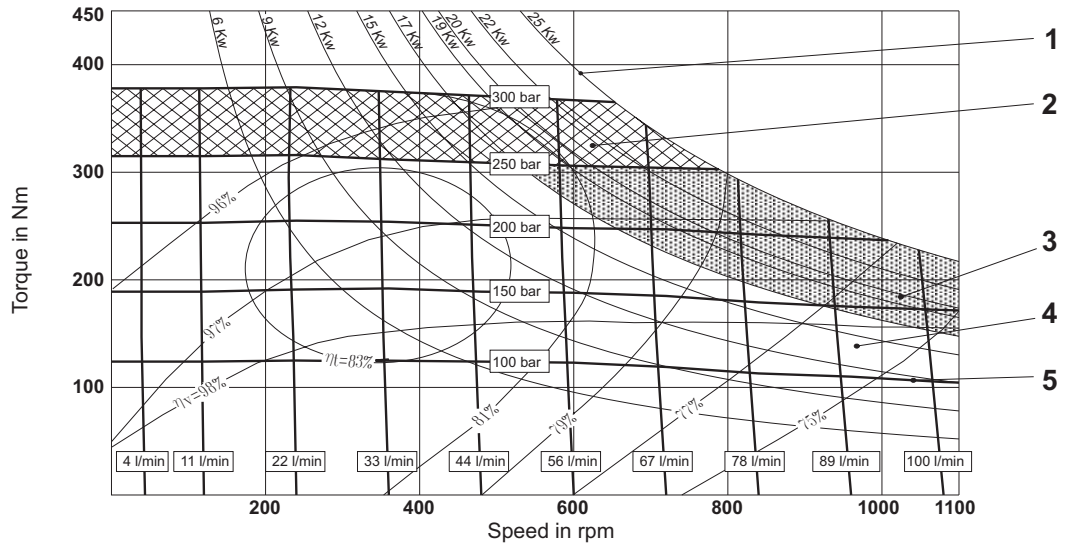

MR 110

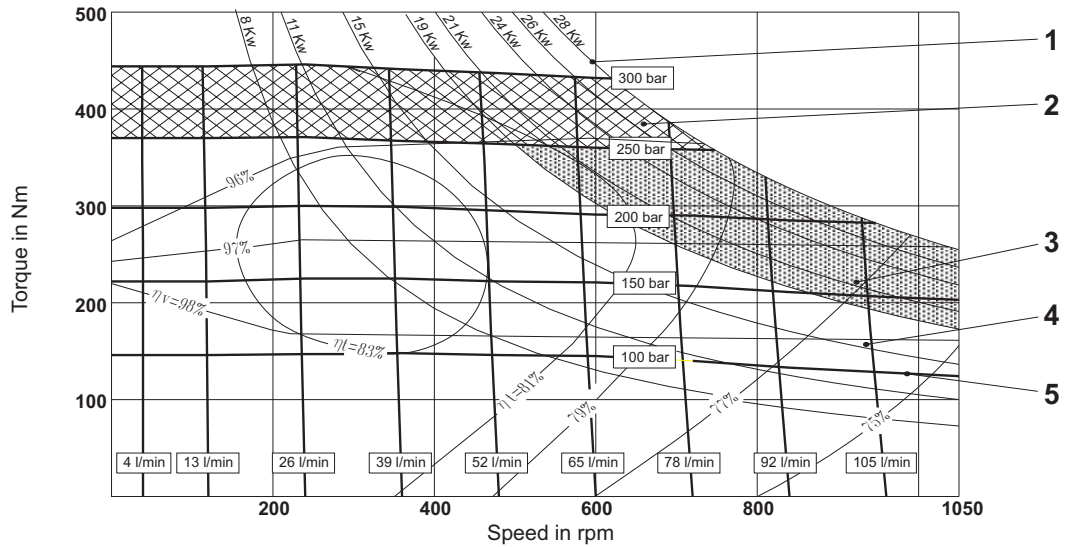

MR 125

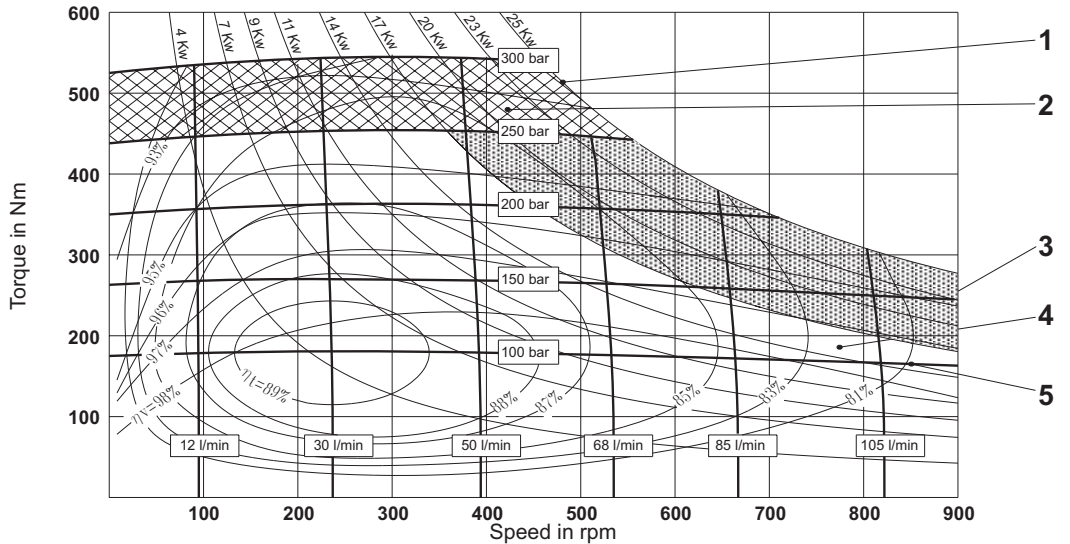

OPERATING DIAGRAM

(average values) measured at  $V = 36 \text{ mm}^2/\text{s}$ ;  $t = 45^\circ \text{ C}$ ;  $p_{\text{outlet}} = 0 \text{ bar}$

- 1 Output power
- 2 Intermittent operating area
- 3 Continuous operating area with flushing
- 4 Continuous operating area
- 5 Inlet pressure
- $\eta_t$  Total efficiency
- $\eta_v$  Volumeter efficiency

MR 160

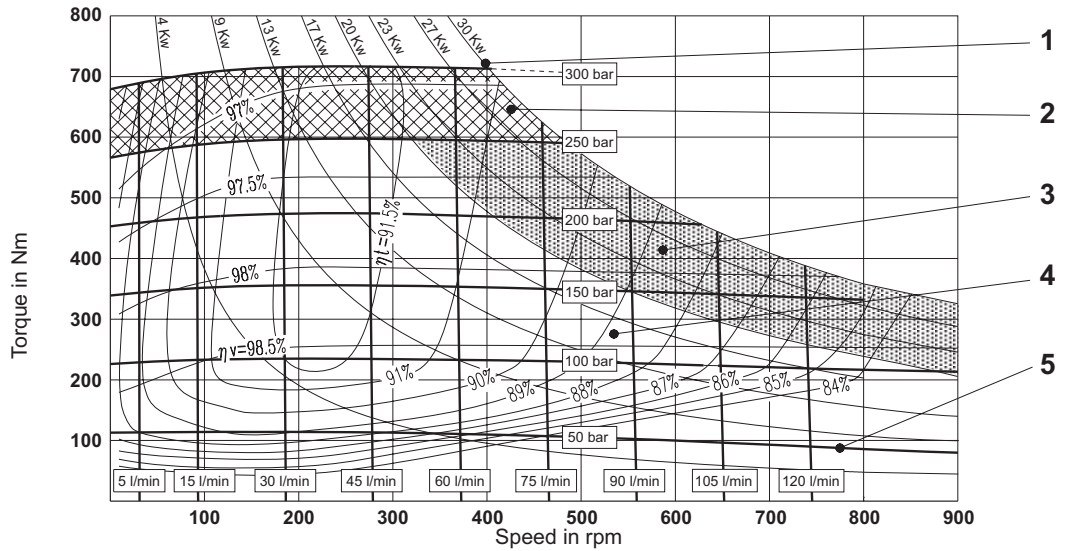

MR 190

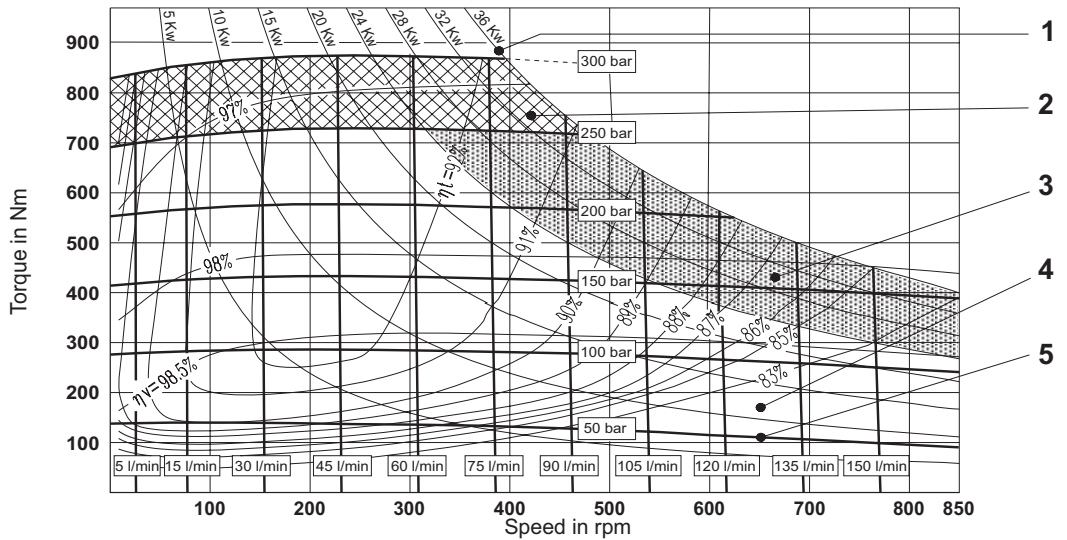

MR 200

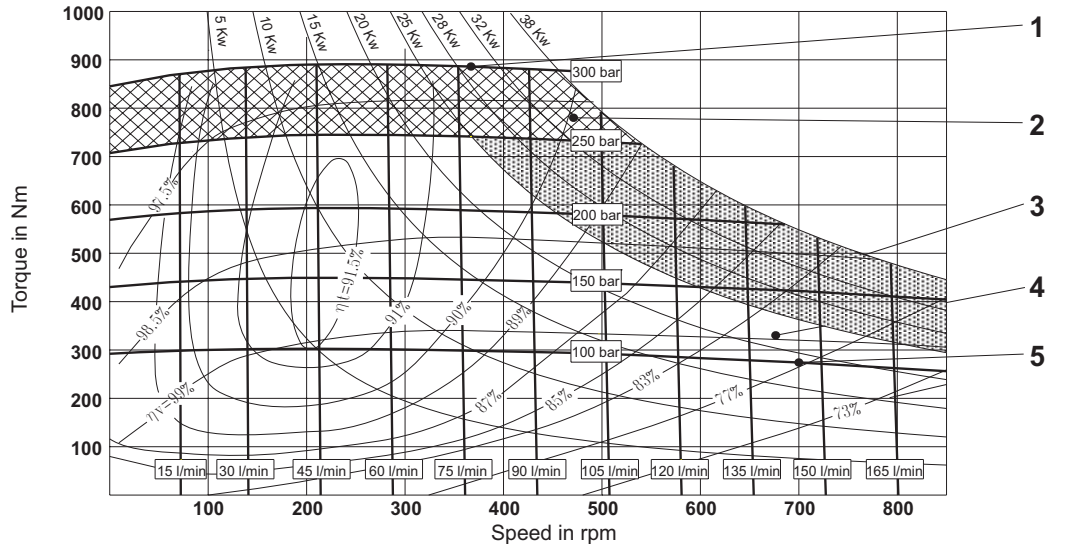

OPERATING DIAGRAM

(average values) measured at  $V = 36 \text{ mm}^2/\text{s}$ ;  $t = 45^\circ \text{ C}$ ;  $p_{\text{outlet}} = 0 \text{ bar}$

- 1 Output power
- 2 Intermittent operating area
- 3 Continuous operating area with flushing
- 4 Continuous operating area
- 5 Inlet pressure
- $\eta_t$  Total efficiency
- $\eta_v$  Volumeter efficiency

MR 250

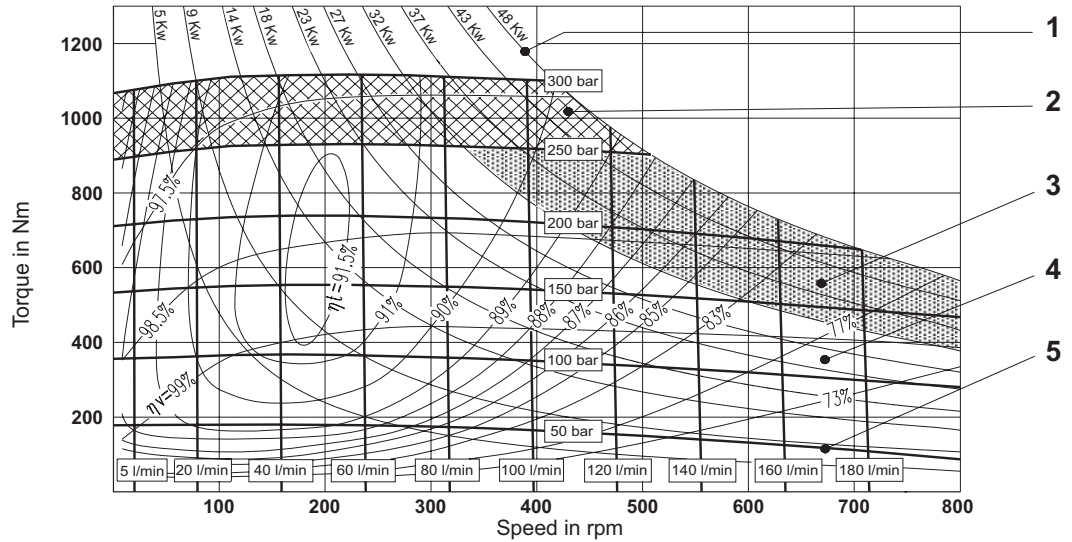

MR 300

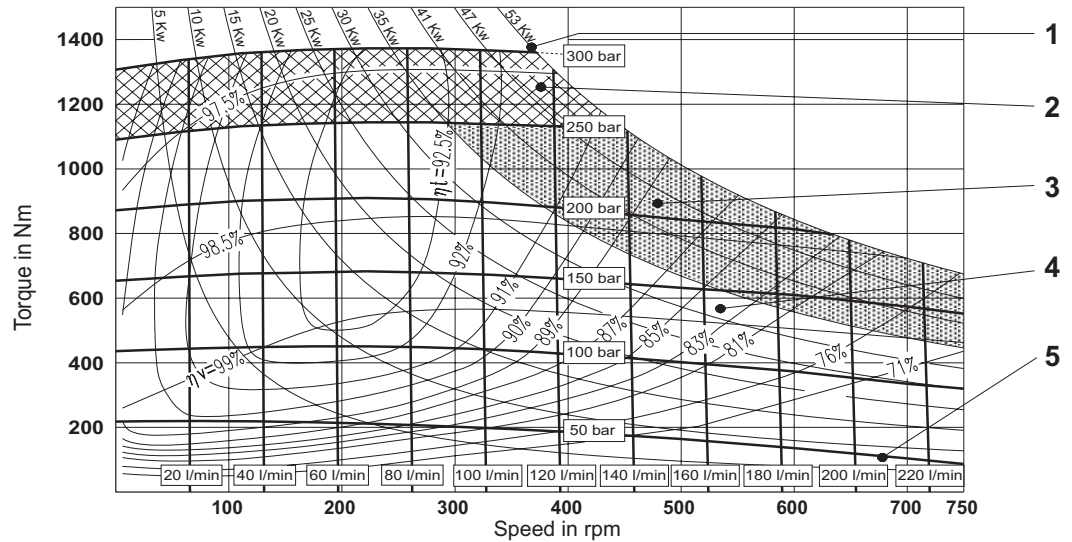

MRE 330

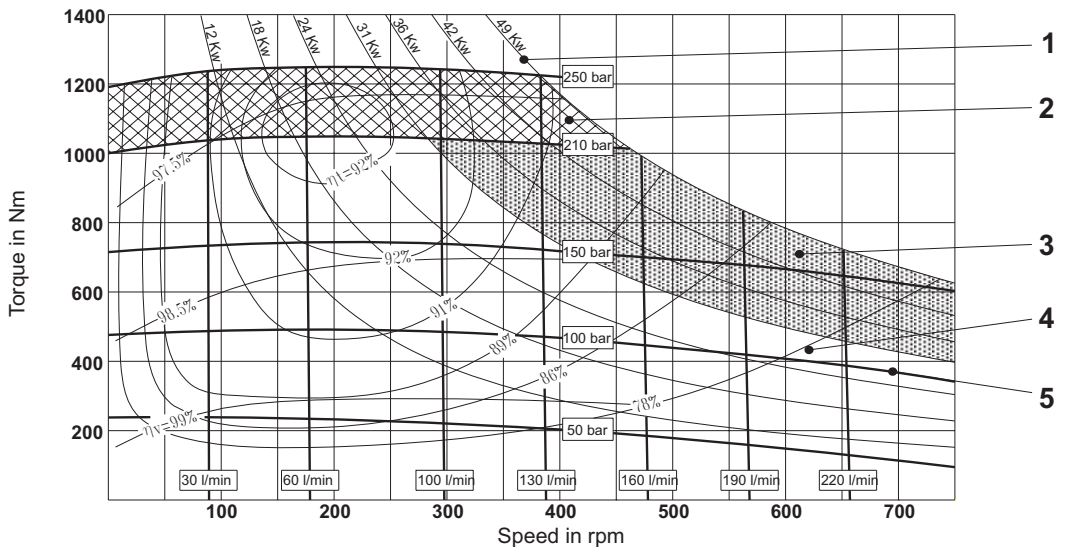

OPERATING DIAGRAM

(average values) measured at  $V = 36 \text{ mm}^2/\text{s}$ ;  $t = 45^\circ \text{ C}$ ;  $p_{\text{outlet}} = 0 \text{ bar}$

- 1 Output power
- 2 Intermittent operating area
- 3 Continuous operating area with flushing
- 4 Continuous operating area
- 5 Inlet pressure
- $\eta_t$  Total efficiency
- $\eta_v$  Volumeter efficiency

MR 350

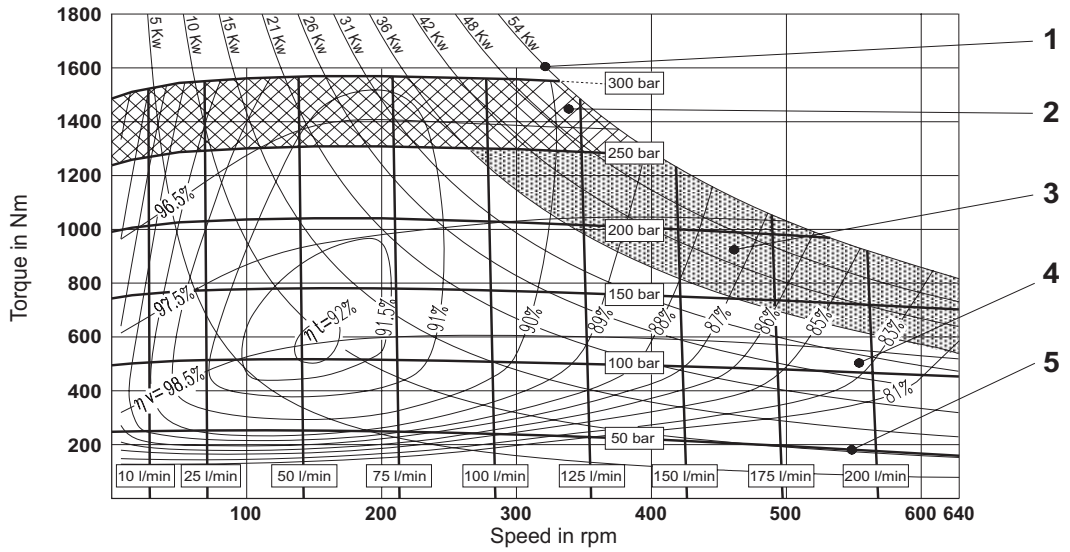

MR 450

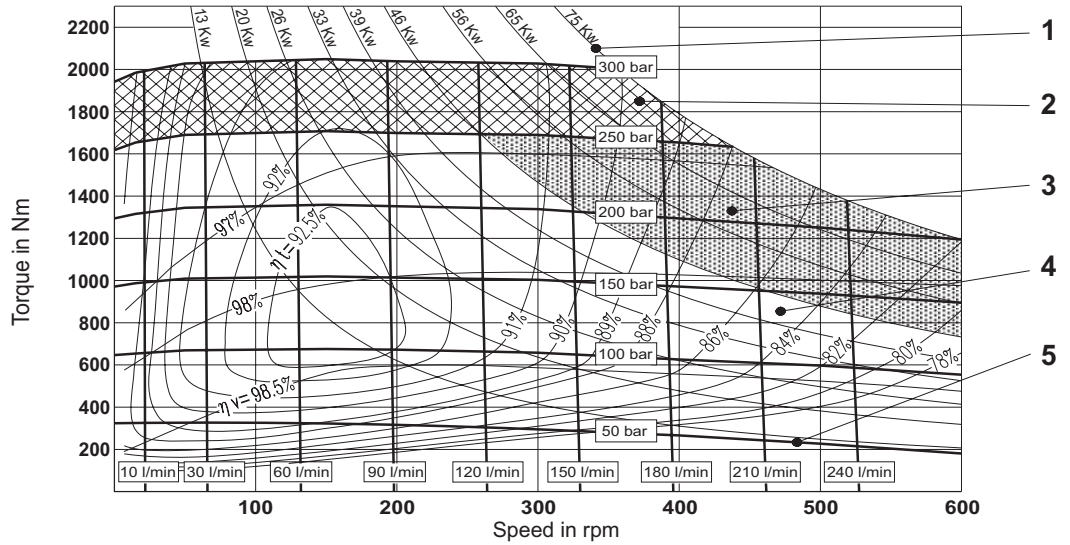

MRE 500

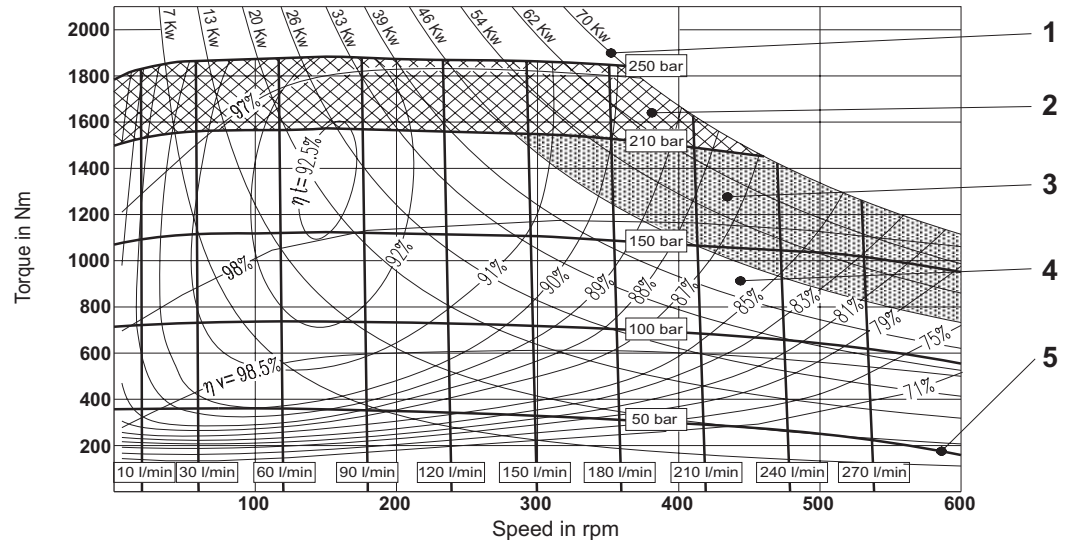



OPERATING DIAGRAM

(average values) measured at  $V = 36 \text{ mm}^2/\text{s}$ ;  $t = 45^\circ \text{ C}$ ;  $p_{\text{outlet}} = 0 \text{ bar}$

- 1 Output power
- 2 Intermittent operating area
- 3 Continuous operating area with flushing
- 4 Continuous operating area
- 5 Inlet pressure
- $\eta_t$  Total efficiency
- $\eta_v$  Volumeter efficiency

MR 600

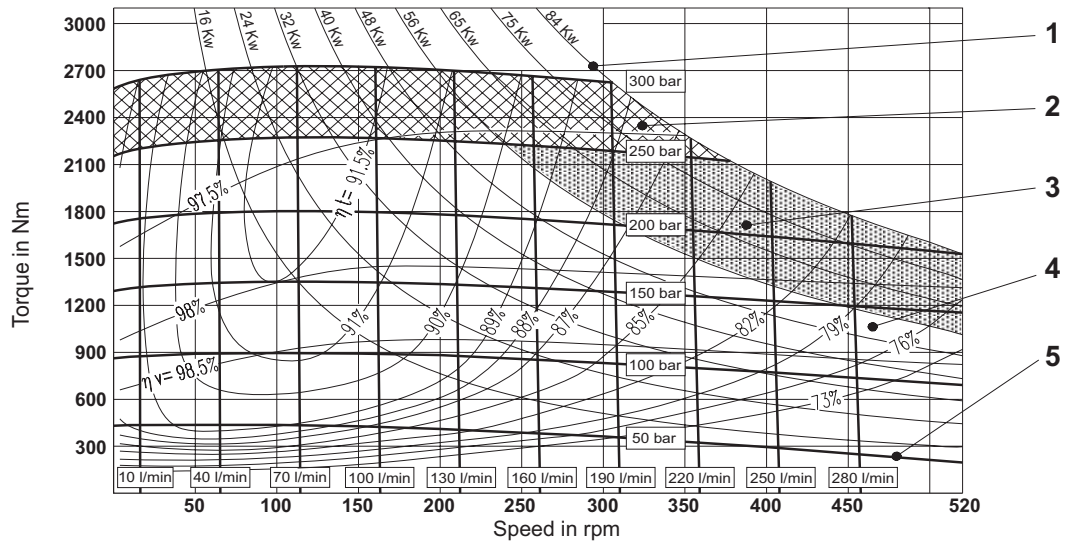

MR 700

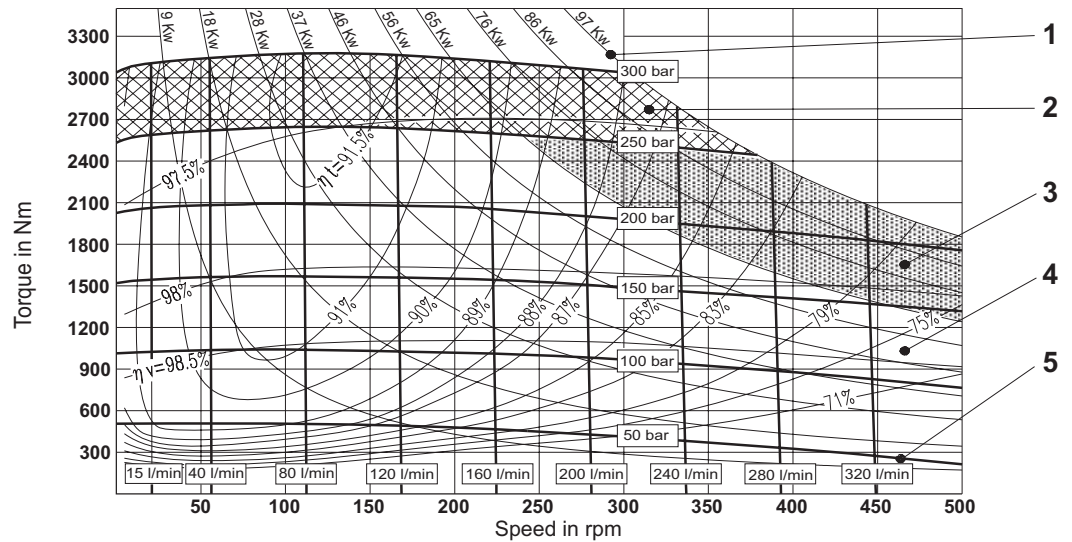

MRE 800

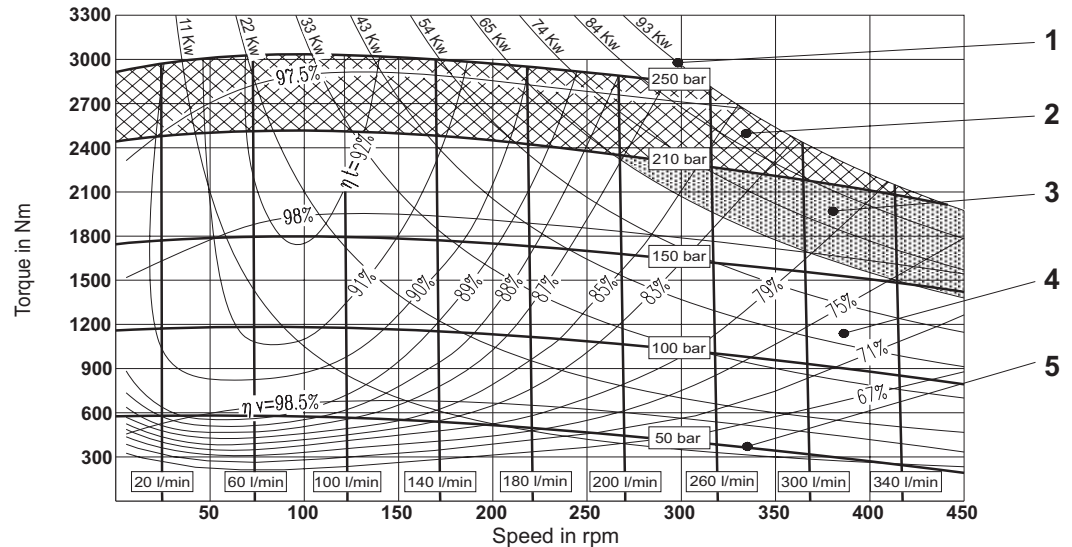

OPERATING DIAGRAM

(average values) measured at  $V = 36 \text{ mm}^2/\text{s}$ ;  $t = 45^\circ \text{ C}$ ;  $p_{\text{outlet}} = 0 \text{ bar}$

- 1 Output power
- 2 Intermittent operating area
- 3 Continuous operating area with flushing
- 4 Continuous operating area
- 5 Inlet pressure
- $\eta_t$  Total efficiency
- $\eta_v$  Volumeter efficiency

MR 1100

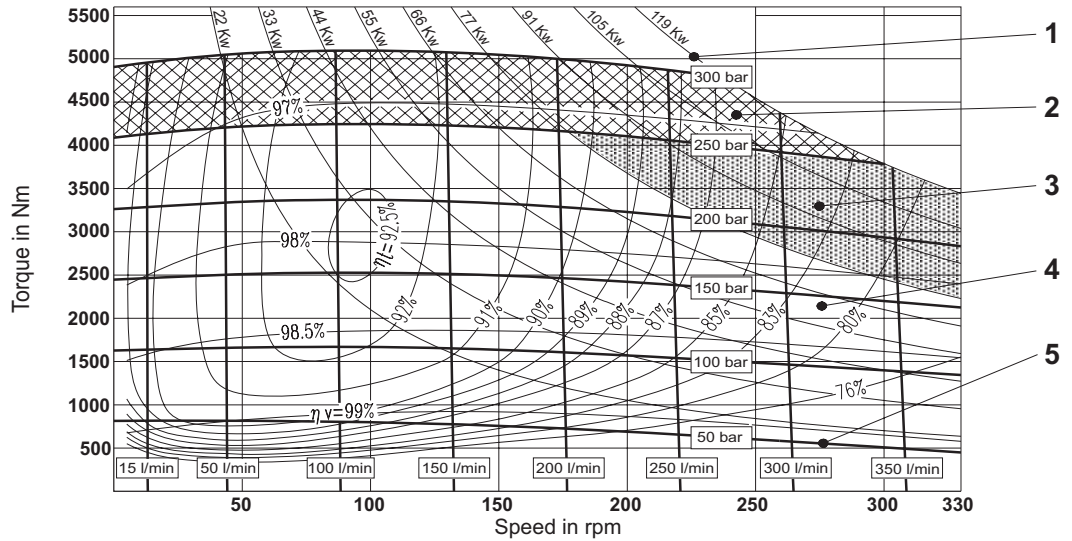

MRE 1400

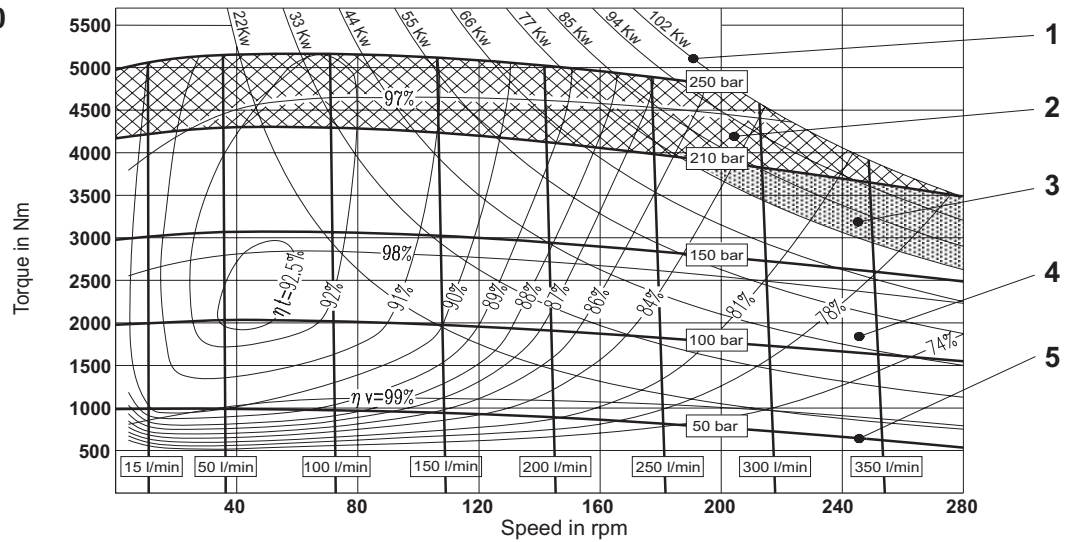

MR 1600

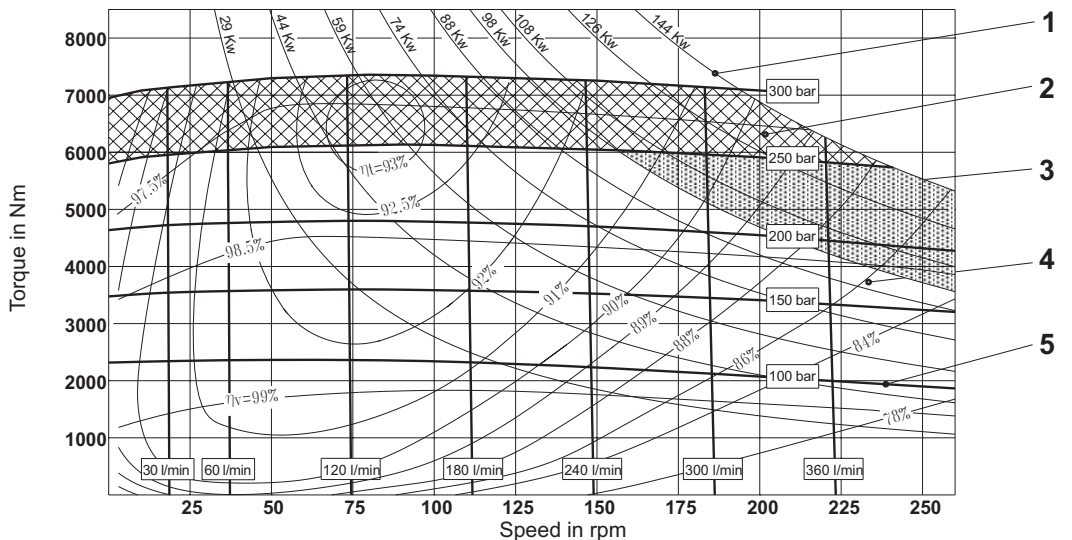

OPERATING DIAGRAM

(average values) measured at  $V = 36 \text{ mm}^2/\text{s}$ ;  $t = 45^\circ \text{ C}$ ;  $p_{\text{outlet}} = 0 \text{ bar}$

- 1 Output power
- 2 Intermittent operating area
- 3 Continuous operating area with flushing
- 4 Continuous operating area
- 5 Inlet pressure
- $\eta_t$  Total efficiency
- $\eta_v$  Volumeter efficiency

MR 1800

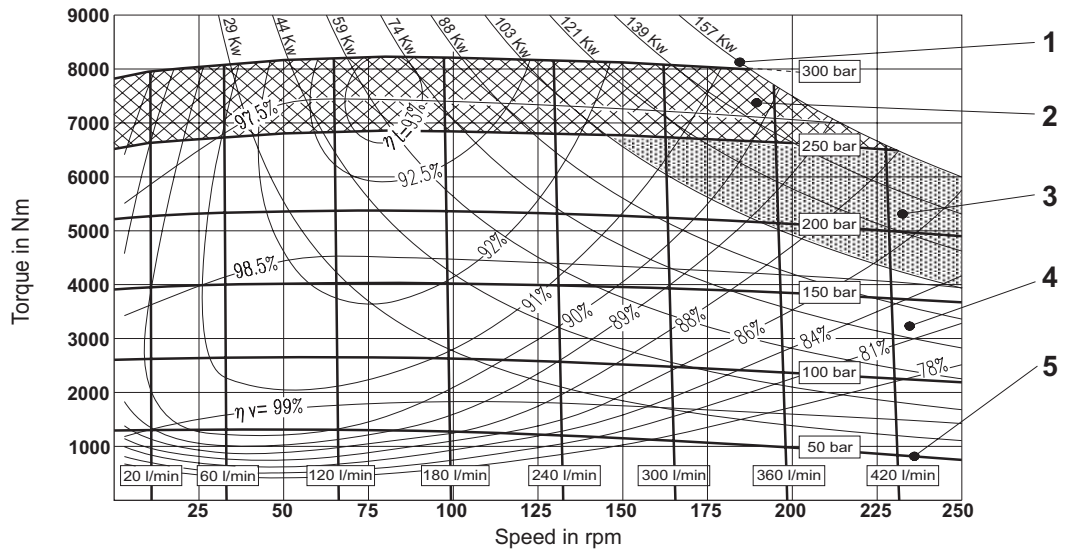

MRE 2100

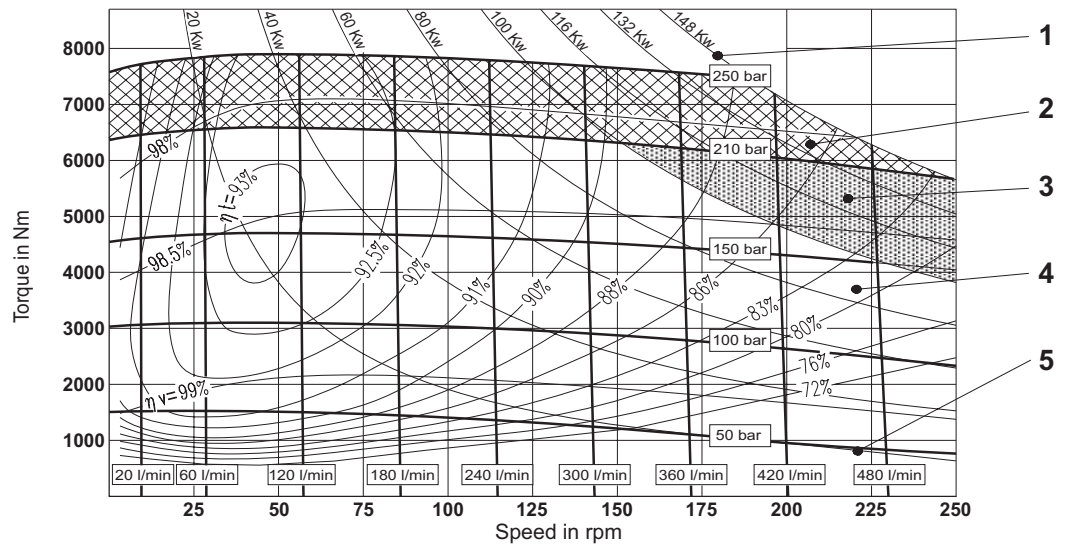

MR 2400

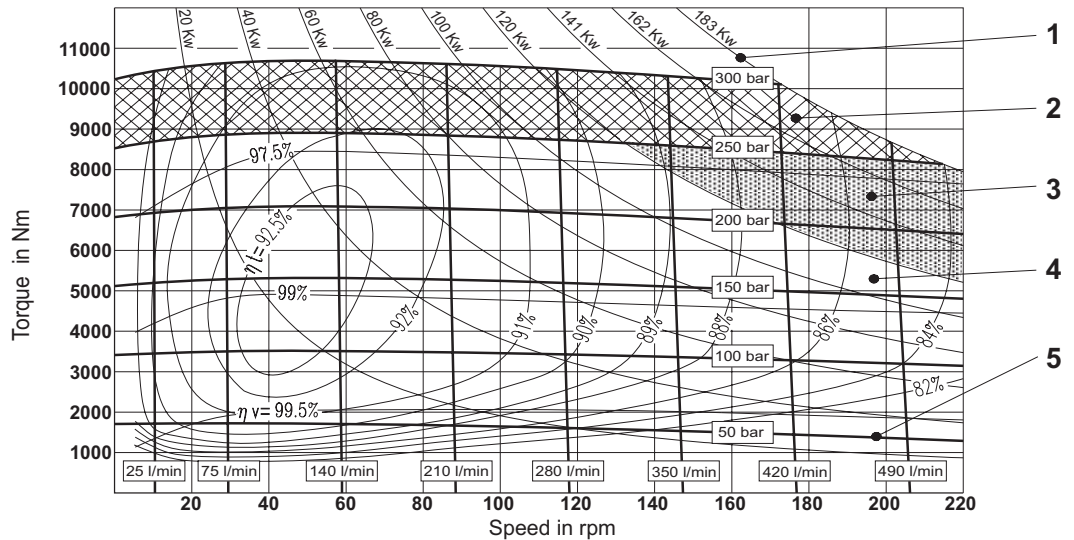



OPERATING DIAGRAM

(average values) measured at  $V = 36 \text{ mm}^2/\text{s}$ ;  $t = 45^\circ \text{ C}$ ;  $p_{\text{outlet}} = 0 \text{ bar}$

- 1 Output power
- 2 Intermittent operating area
- 3 Continuous operating area with flushing
- 4 Continuous operating area
- 5 Inlet pressure
- $\eta_t$  Total efficiency
- $\eta_v$  Volumeter efficiency

MR 2800

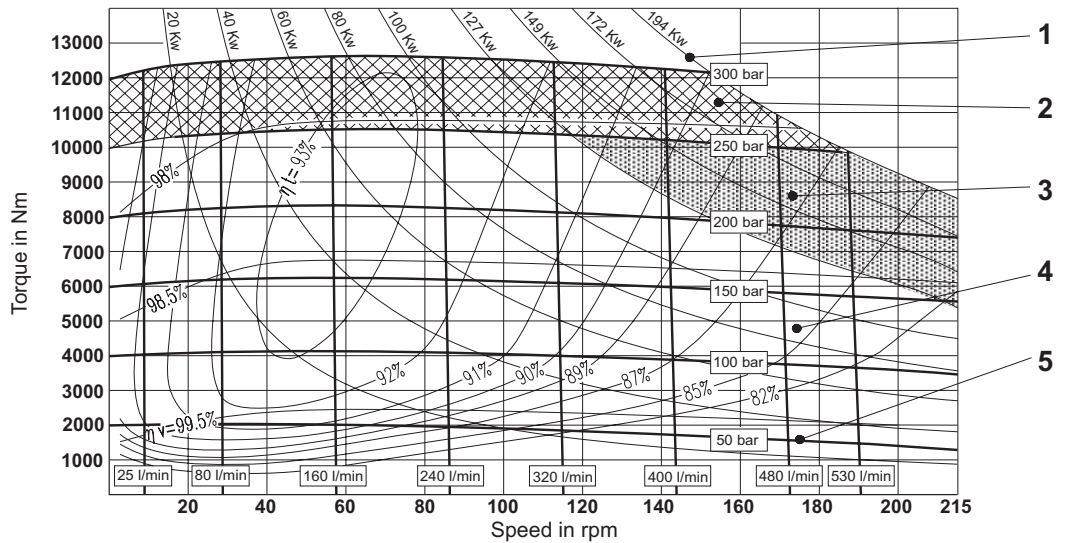

MRE 3100

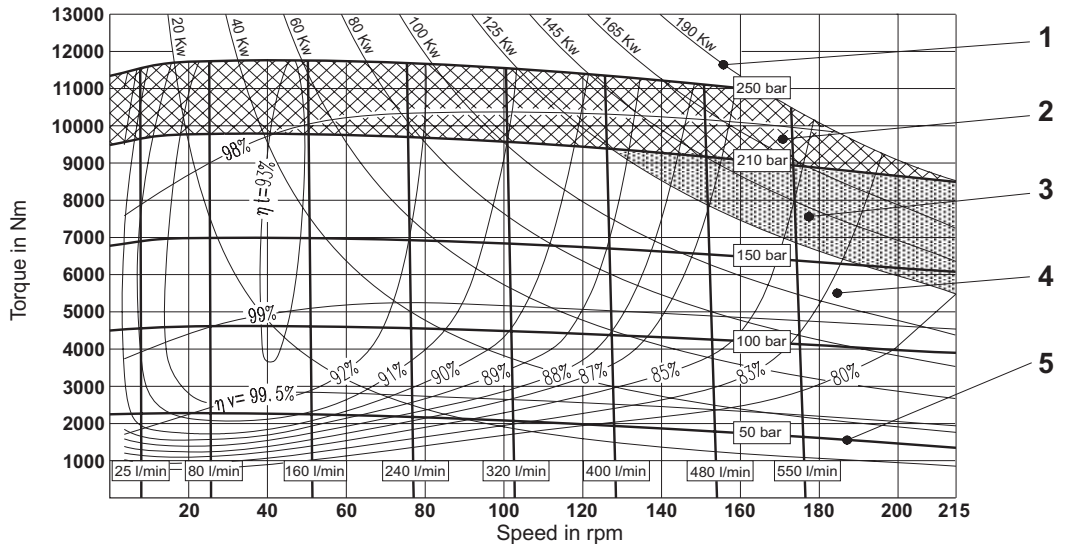

MR 3600

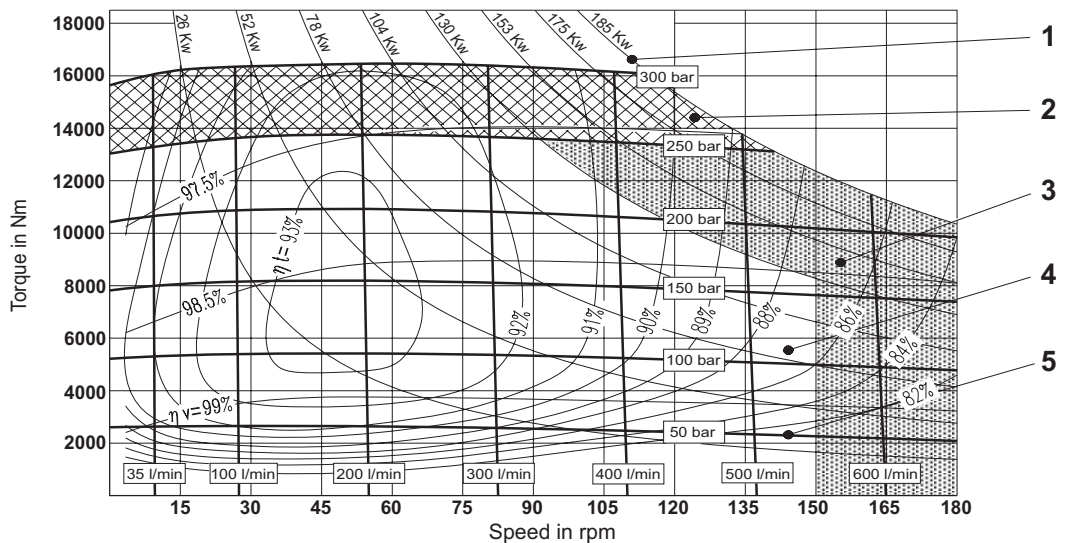

OPERATING DIAGRAM

(average values) measured at  $V = 36 \text{ mm}^2/\text{s}$ ;  $t = 45^\circ \text{ C}$ ;  $p_{\text{outlet}} = 0 \text{ bar}$

- 1 Output power
- 2 Intermittent operating area
- 3 Continuous operating area with flushing
- 4 Continuous operating area
- 5 Inlet pressure
- $\eta_t$  Total efficiency
- $\eta_v$  Volumeter efficiency

MR 4500

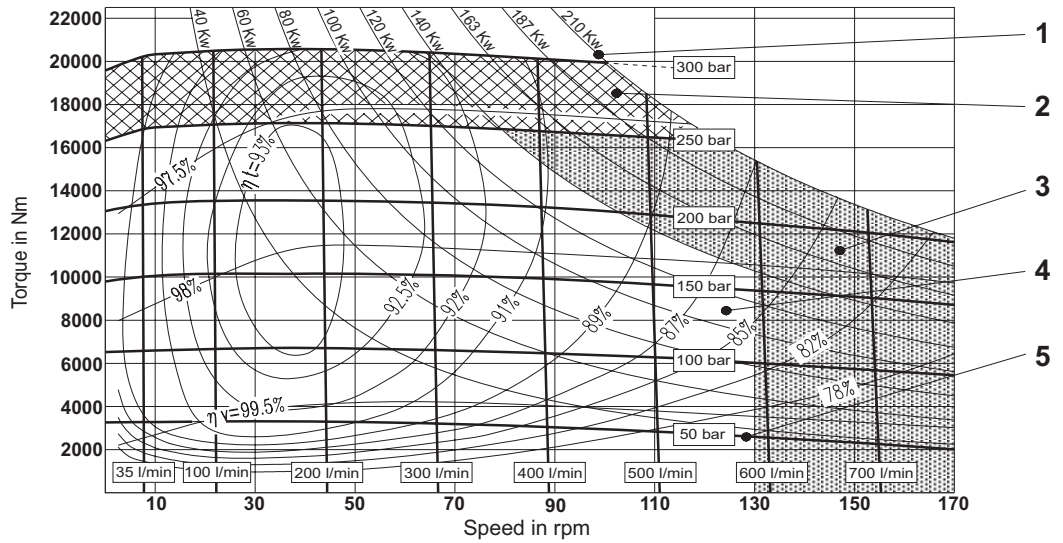

MRE 5400

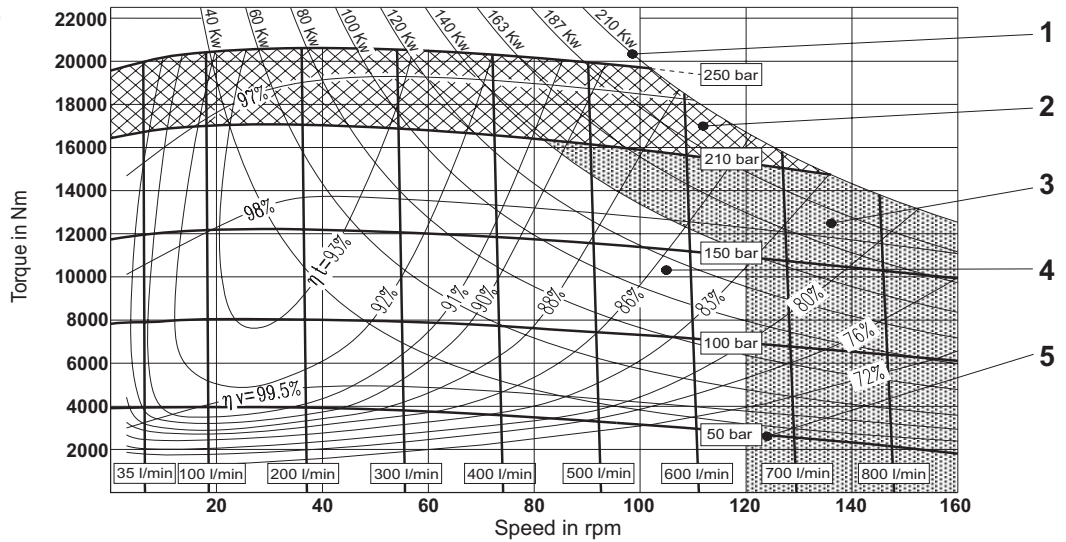

MR 6500

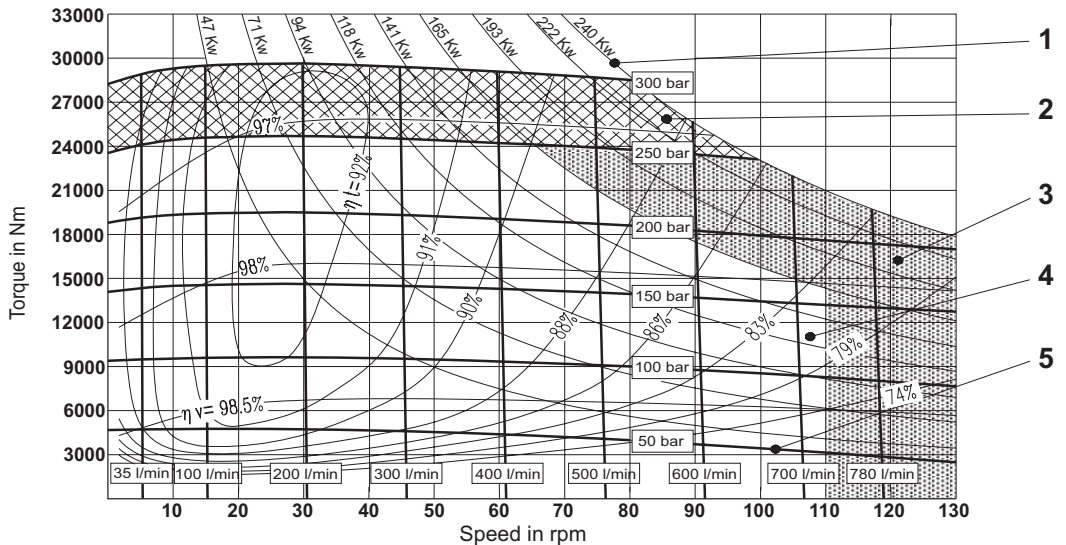

OPERATING DIAGRAM

(average values) measured at  $V = 36 \text{ mm}^2/\text{s}$ ;  $t = 45^\circ \text{ C}$ ;  $p_{\text{outlet}} = 0 \text{ bar}$

- 1 Output power
- 2 Intermittent operating area
- 3 Continuous operating area with flushing
- 4 Continuous operating area
- 5 Inlet pressure
- $\eta_t$  Total efficiency
- $\eta_v$  Volumetric efficiency

MR 7000

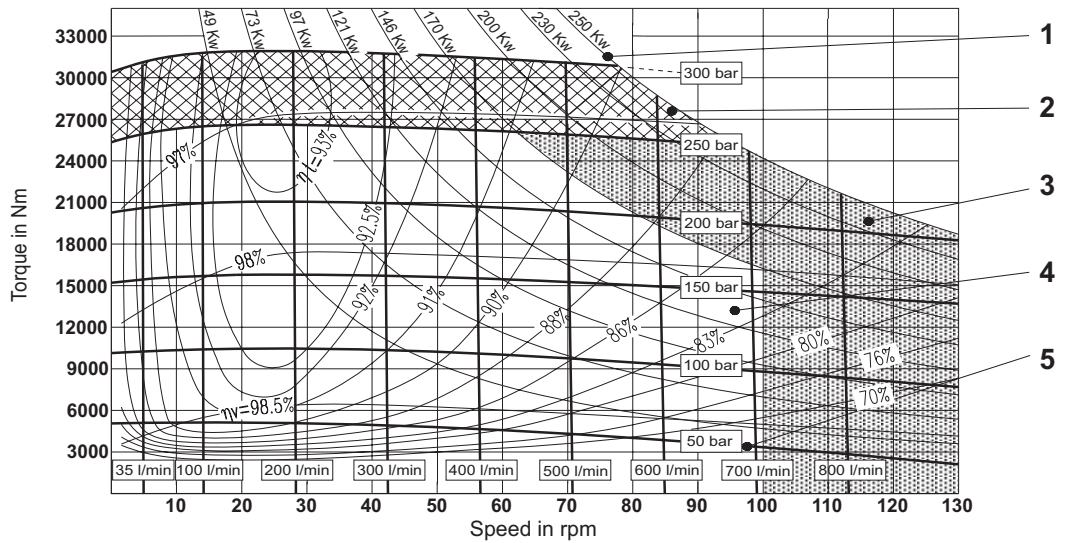

MRE 8200

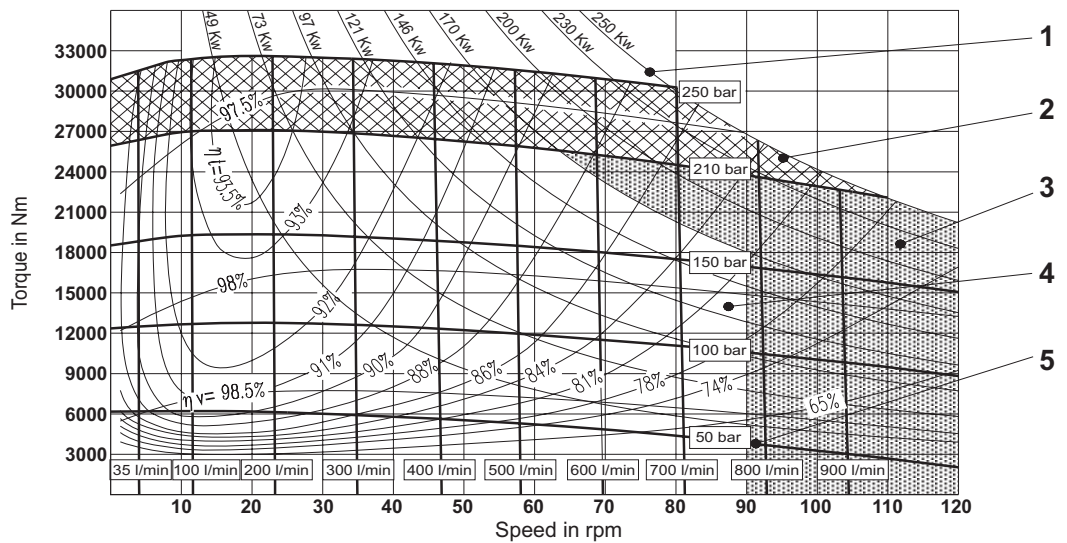

**OPERATING DIAGRAM** (average values) measured at  $V = 36 \text{ mm}^2/\text{s}$ ;  $t = 45^\circ \text{ C}$ ;  $p_{\text{outlet}} = 0 \text{ bar}$   
 Min. required pressure difference  $\Delta p$  with idling speed (shaft unloaded)

**MR**  
**33 - 110**

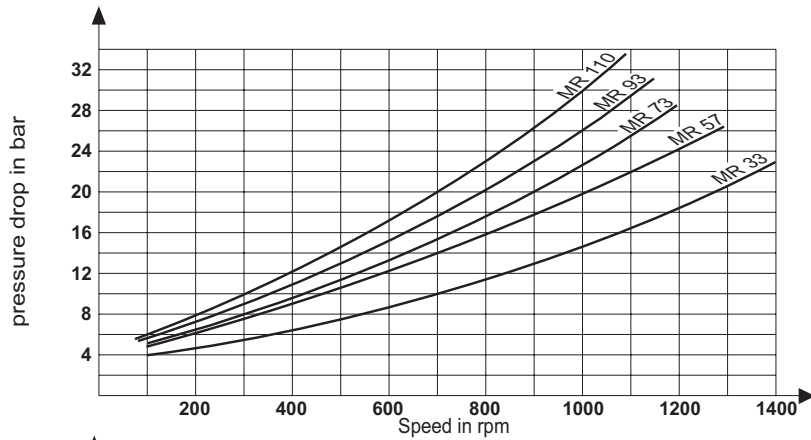

**MR - MRE**  
**125 - 330**

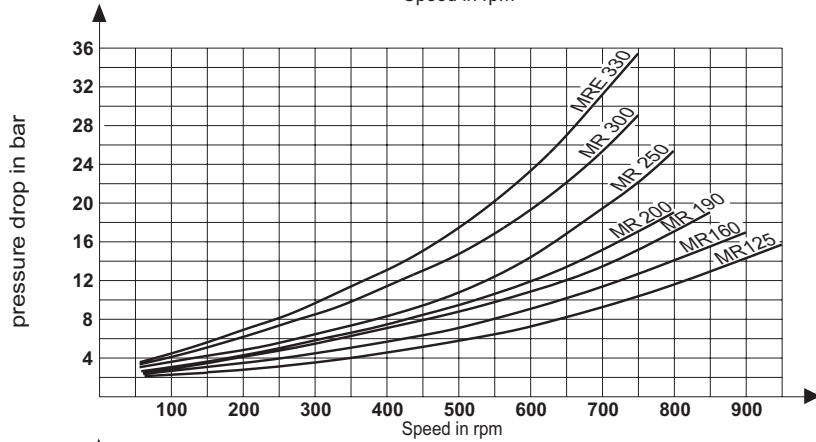

**MR - MRE**  
**350 - 800**

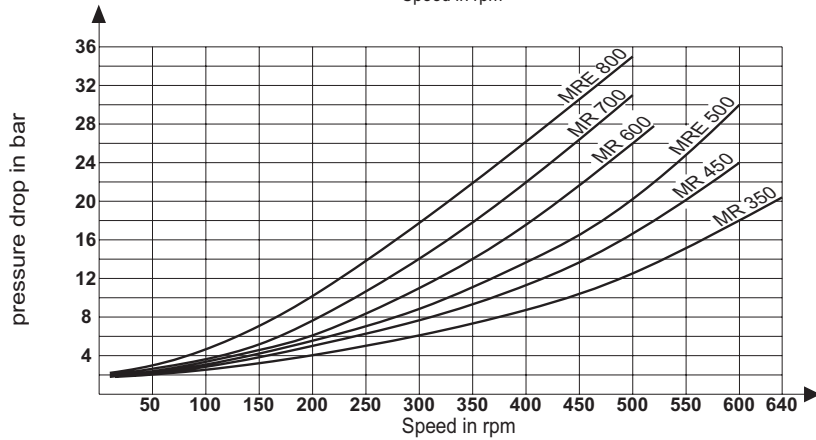

**MR - MRE**  
**1100 - 2100**

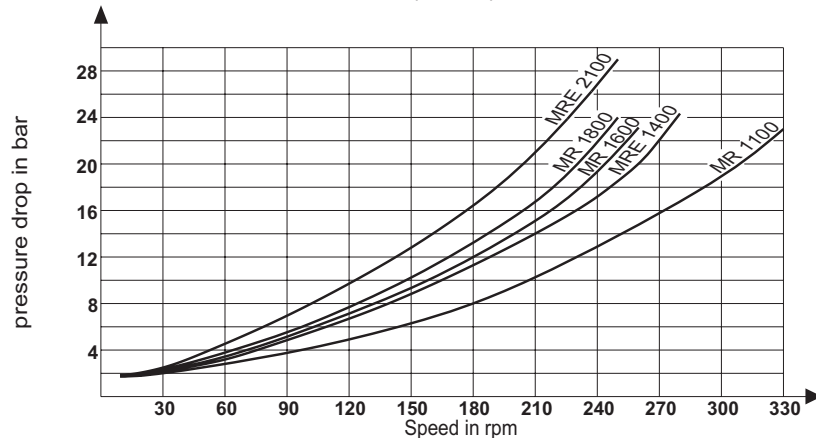

OPERATINGDIAGRAM (average values) measured at  $V = 36 \text{ mm}^2/\text{s}$ ;  $t = 45^\circ \text{ C}$ ;  $p_{\text{outlet}} = 0 \text{ bar}$   
 Min. required pressure difference  $\Delta p$  with idling speed (shaft unloaded)

**MR - MRE**  
**2400 - 8200**

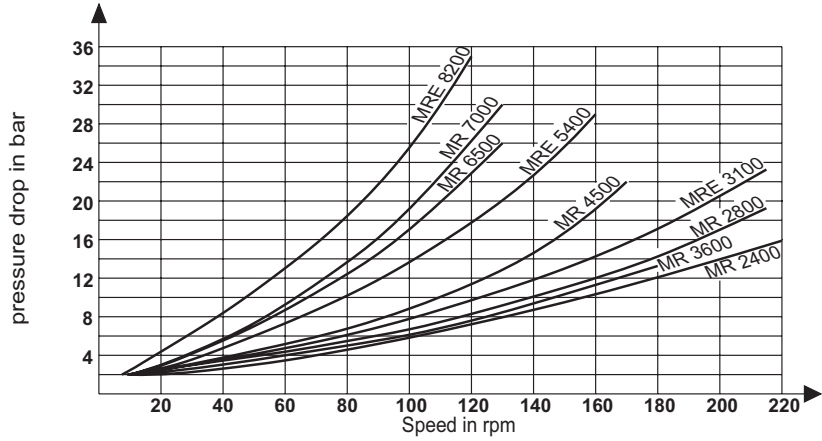

Minimum boost pressure during pump operation

**MR**  
**33 - 110**

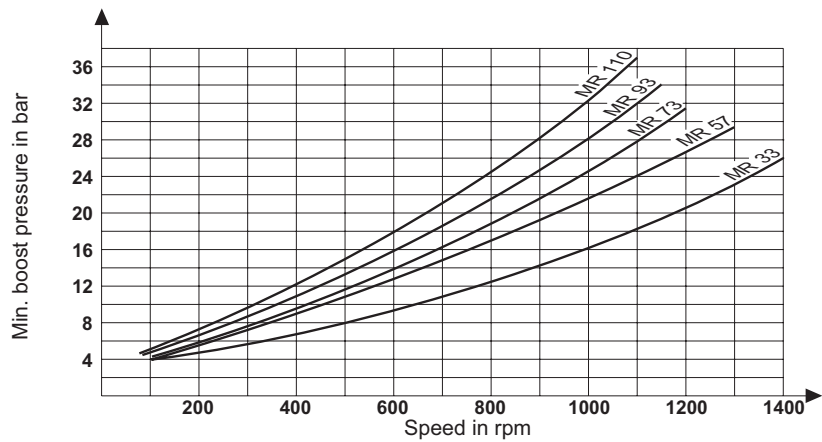

**MR - MRE**  
**125 - 330**

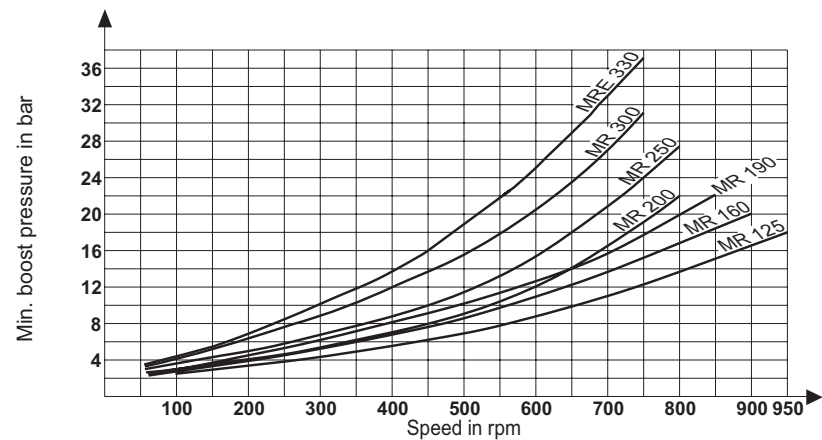

OPERATING DIAGRAM (average values) measured at  $V = 36 \text{ mm}^2/\text{s}$ ;  $t = 45^\circ \text{ C}$ ;  $p_{\text{outlet}} = 0 \text{ bar}$

Minimum boost pressure during pump operation

**MR - MRE  
350 - 800**

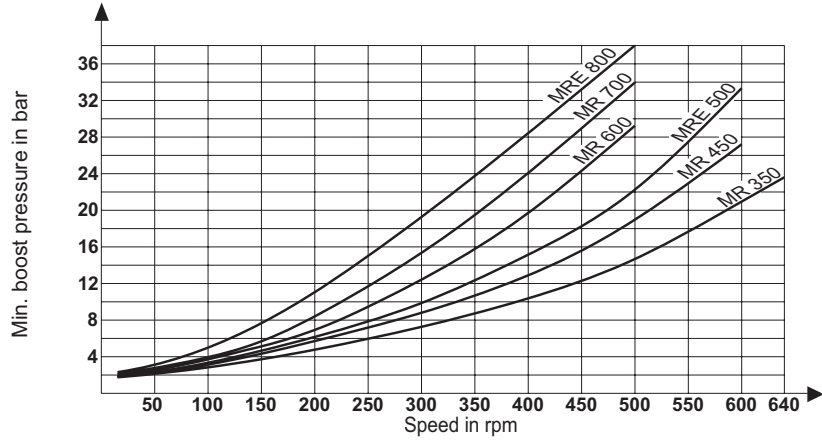

**MR - MRE  
1100 - 2100**

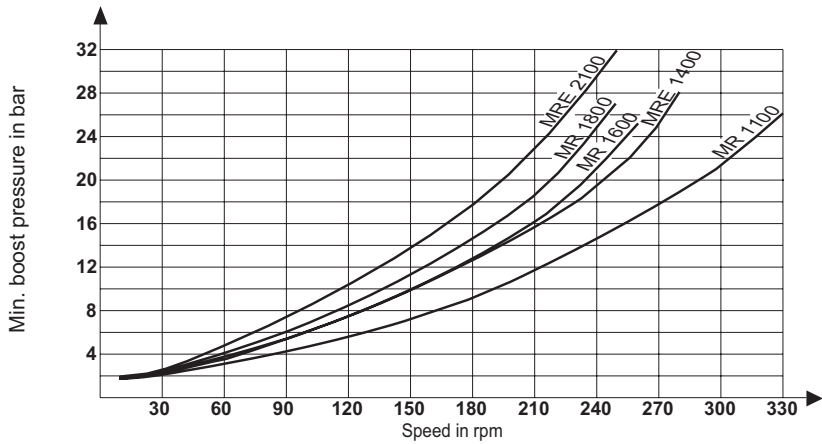

**MR - MRE  
2400 - 8200**

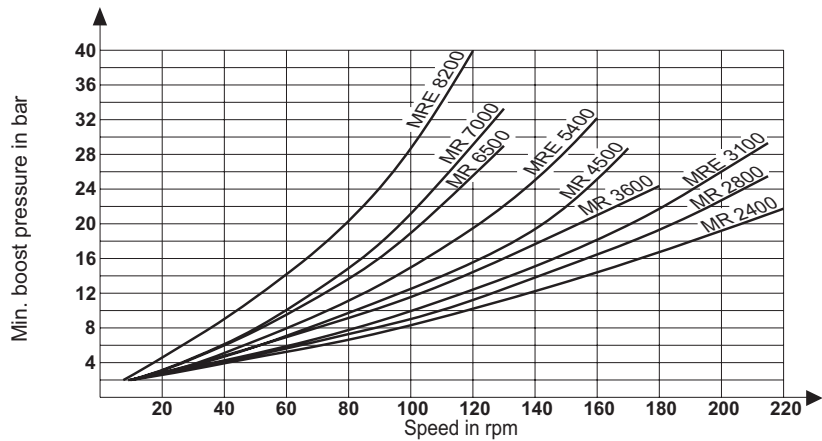



RADIAL LOAD

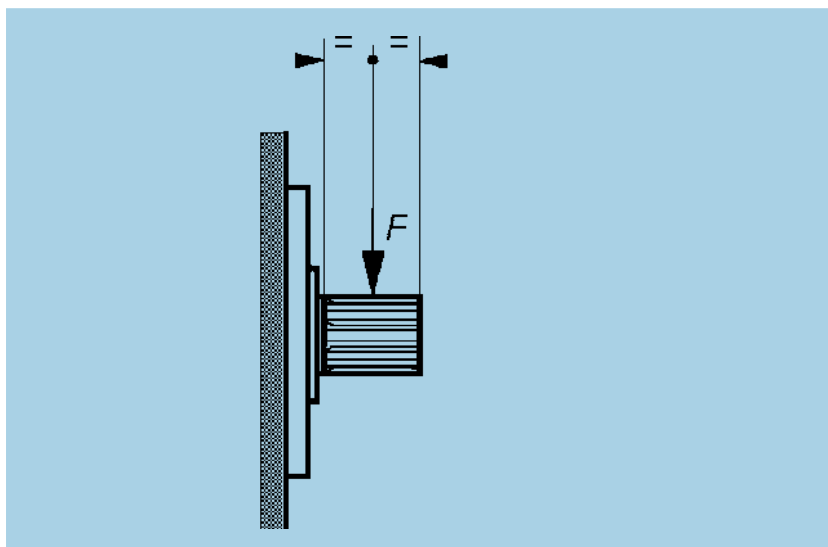

MOTOR TYPE	RADIAL FORCE <sup>MAX I</sup> BRIEFLY PERMITTED WITH DYNAMIC LOAD F in kN <sup>1)</sup>	MAX. PERMITTED RADIAL FORCE IN SHAFT CENTRE BASED ON L <sub>H10</sub> 5000 HOURS			speed in rpm
		INPUT PRESSURE 200 bar F in kN	INPUT PRESSURE 150 bar F in kN	INPUT PRESSURE 100 bar F in kN	
MR 33	19,0	9,5	10,2	10,6	400
MR 57	19,0	9,5	10,2	10,6	400
MR 73	22,5	9,0	11,6	13,5	350
MR 93	22,5	9,0	11,6	13,5	350
MR 110	22,5	9,0	11,6	13,5	350
MR 125	22,5	5,0	9,9	12,9	275
MR 160	22,5	5,0	9,9	12,9	275
MR 190	22,5	5,0	9,9	12,9	275
MR 200 *	-	-	-	-	-
MR 250	28,0	5,6	9,9	12,6	250
MR 300	28,0	5,6	9,9	12,6	250
MR 350	35,0	14,5	18,4	21,2	225
MR 450	35,0	14,5	18,4	21,2	225
MR 600	43,0	15,0	22,5	27,3	200
MR 700	43,0	15,0	22,5	27,3	200
MR 1100	54,0	18,5	28,5	35,2	150
MR 1600	68,0	26,2	40,6	50,0	125
MR 1800	68,0	26,2	40,6	50,0	125
MR 2400	85,0	50,1	66,0	76,8	110
MR 2800	85,0	54,0	69,0	79,4	100
MR 3600	108,0	55,0	90,0	103,0	100
MR 4500	108,0	78,0	97,0	109,0	85
MR 6500	134,0	74,0	123,0	141,0	50
MR 7000	134,0	74,0	123,0	141,0	50
MRE 330	28,0	4,5	8,5	11,9	250
MRE 500	35,0	12,4	17,3	20,8	225
MRE 800	43,0	8,5	19,8	26,3	200
MRE 1400	54,0	8,6	24,0	33,6	140
MRE 2100	68,0	12,5	35,6	48,3	120
MRE 3100	85,0	45,0	64,5	77,6	100
MRE 5400	108,0	63,0	90,2	107,3	80
MRE 8200	134,0	68,0	110,0	128,0	50

<sup>1)</sup> in accordance with the dynamic condition, higher values can be accepted - MR 200\* only code "F1"



BEARING LIFE

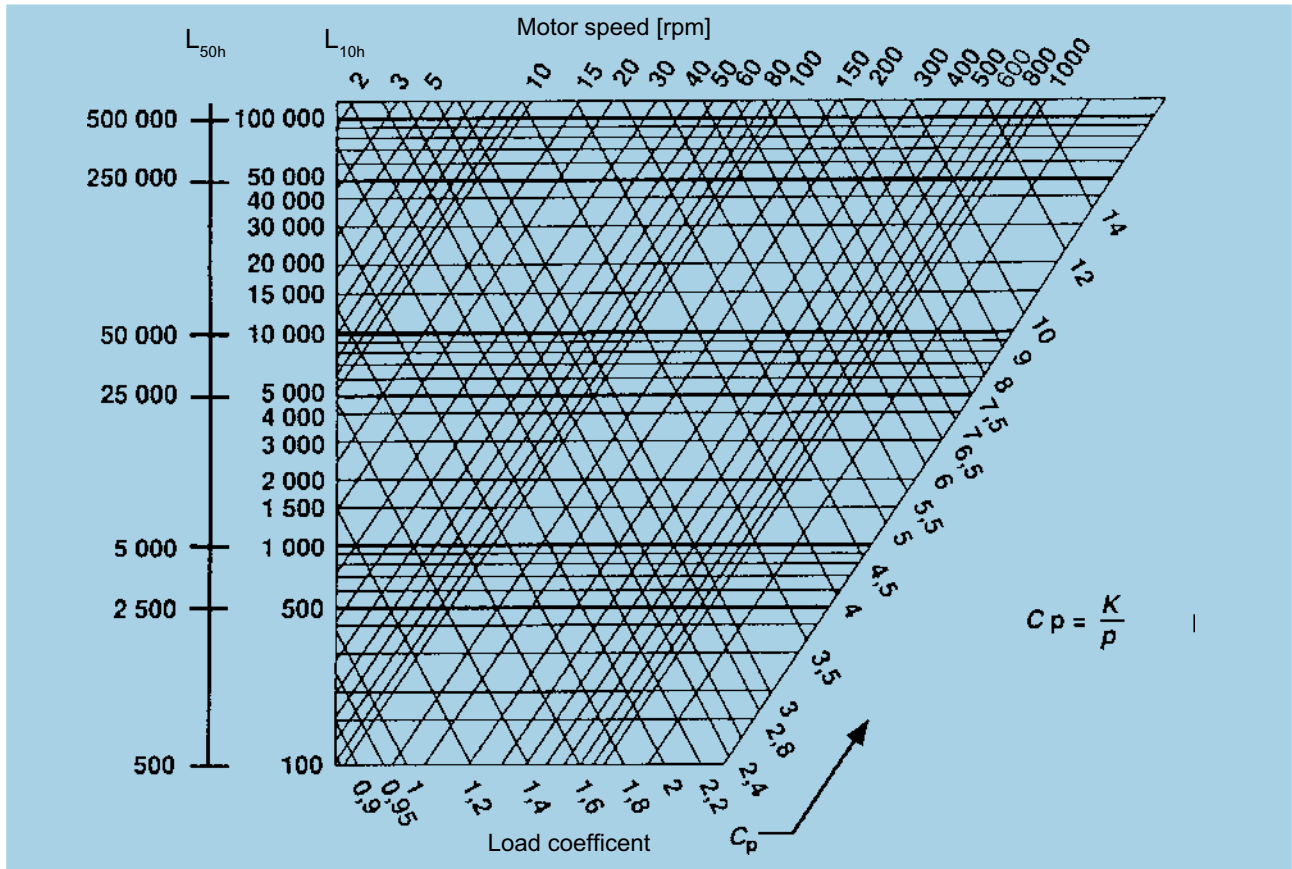

C<sub>p</sub> = Load coefficient  
 K = Service life coefficient for standard bearing  
 p = operating pressure in bar

L<sub>10h</sub> is the theoretically service life value normally reached or exceeded by the 90% of the bearings.  
 50 % of the bearings reach the value L<sub>50h</sub> = 5 times L<sub>10h</sub>.

MOTOR TYPE	K	MOTOR TYPE	K	MOTOR TYPE	K
MR 33	2600	MRE 330	1000	MRE 2100	800
MR 57	2600	MR 350	1340	MR 2400	1020
MR 73	1540	MR 450	1340	MR 2800	1020
MR 93	1540	MRE 500	1215	MRE 3100	920
MR 110	1540	MR 600	1080	MR 3600	880
MR 125	1120	MR 700	1080	MR 4500	880
MR 160	1120	MRE 800	950	MRE 5400	730
MR 190	1120	MR 1100	1020	MR 6500	880
MR 200	1120	MRE 1400	840	MR 7000	880
MR 250	1120	MR 1600	920	MRE 8200	680
MR 300	1120	MR 1800	920		

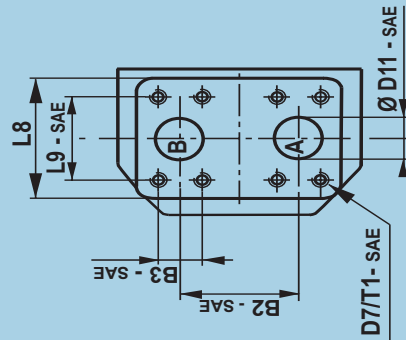
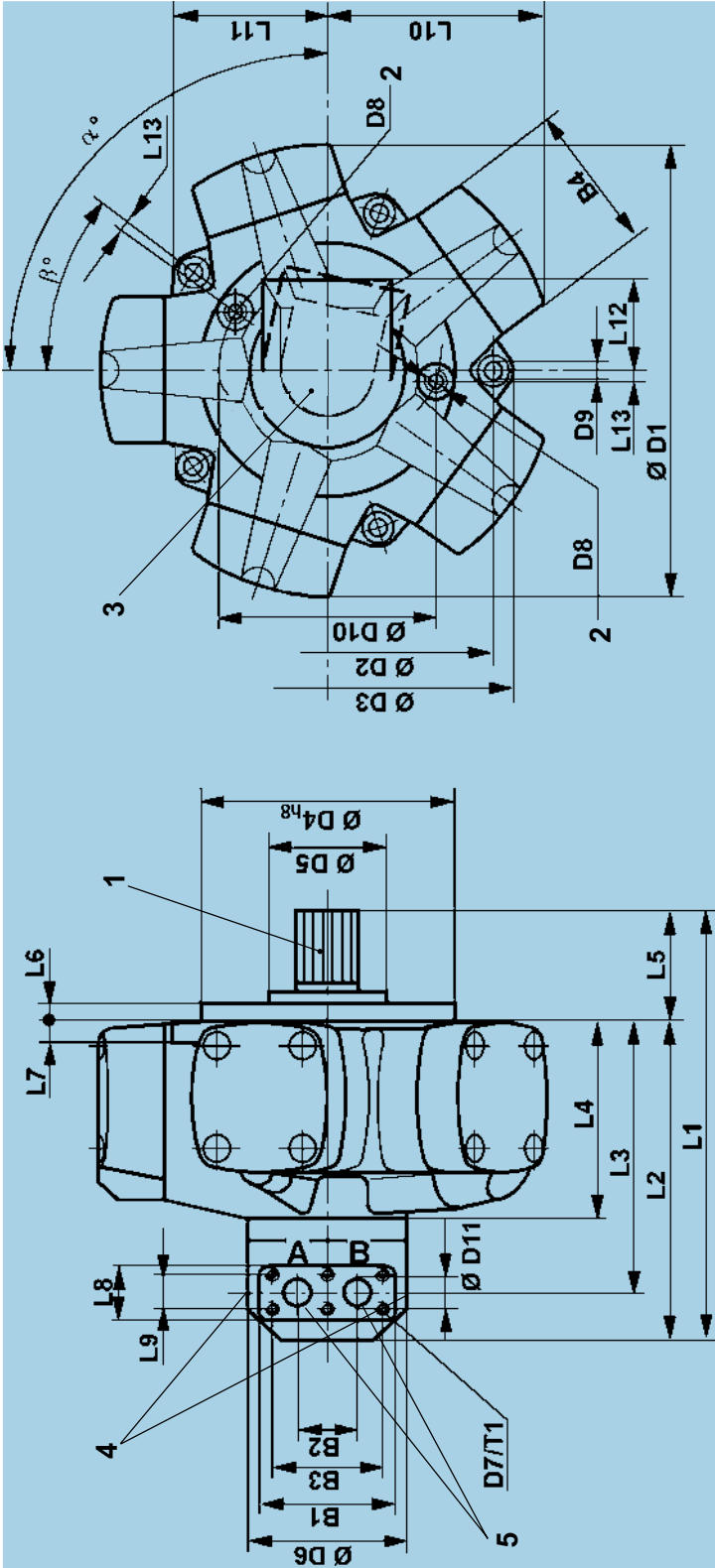

1 Splined shaft with flank contact (for dimension see page 26)  
Ordering code "N1"  
(for further shaft ends see page 26 - 27)

2 Case drain port BSP threads to ISO 228/1

3 On request the port flange can be rotated by  $72^\circ$   
(For MR 33, MR 57, MR 73, MR 93, MR 110, MR 125, MR 160, MR 190, MR 200, MR 250, MR 300, MRE 330, MR 350, MR 450, MRE 500, MR 600, MR 700, MRE 800 can be rotated by  $36^\circ$ )  
For standard position see angle a.

4 Port 1/4" BSP threads to ISO 228/1 for pressure reading.

5 Rotary valve housing with BSP threads (from MR 2400 to MRE 8200) available on request, please contact Parker Calzoni.

Dir. of Rotation (Viewed on shaft end)	Port inlet	ordering code (see page35)
clockwise	A	"N"
anti-clockwise	B	"S"
clockwise	B	"S"
anti-clockwise	A	"S"

MOTOR TYPE	L1	L2	L3	L4	L5	L6	L7	L8	L9	L9 - SAE		L10	L11	L12	L13	α	β
										* low pressure	* high pressure						
MR 33	253,5	196	148	107	57,2	14	19	70	--	52,4	110,2	78,5	70	19,7	108°	36°	
MR 57																	
MR 73	297	228,5	190,5	131,5	68,5	17	20	54	34	--	119,8	94	72	-	90°	36°	
MR 93																	
MR 110																	
MR 125	309	242	204	145	67	14	16	54	34	--	147,5	103	72	6,5	90°	36°	
MR 160																	
MR 190																	
MR 200	323	242	204	145	81	15	16	54	34	--	153,5	119	72	7,5	90°	36°	
MR 250																	
MR 300																	
MRE 330																	
MR 350	376	279	235	167	97	15	18	70,4	40	--	174,5	130	84	9,5	90°	36°	
MR 450																	
MRE 500																	
MR 600	400	299	255	187	101	15	20	70,4	40	--	192	143	84	8	90°	36°	
MR 700																	
MRE 800																	
MR 1100	458	341	293	203	117	20	22	82	50	--	223	165	105	9	104°	36°	
MRE 1400																	
MR 1600	506	374	326	236	132	21	24	82	50	--	264	197	105	11	90°	36°	
MR 1800																	
MRE 2100																	
MR 2400	619	466	392	285	153	24	26	135	62	69,85	303	221	123	15	90°	36°	
MR 2800																	
MRE 3100																	
MR 3600	699,5	489,5	418,5	307,5	210	34	28	135	68	77,77	359,5	247	123	19	108°	36°	
MR 4500																	
MRE 5400																	
MR 6500	796	566	495	384	230	37	30	135	68	77,77	407,3	247	123	21	108°	36°	
MR 7000																	
MRE 8200																	

\* FOR PRESSURE VALUES PLEASE REFER TO PAG.42 "SAE CONNECTION FLANGES". "SAE PSI" VALUES. -- ALSO AVAILABLE UNC. THREAD, PLEASE CONSULT PARKER CALZONI

MOTOR TYPE	B1	B2	B2 - SAE		B3	B4	B4 - SAE		D1	D2	D3	D4, **	D5	D6	D7-T1	D7-T1 - SAE		D8	D9	D10	D11	ØD11 - SAE	
			* LOW PRESS.	* HIGH PRESS.			* LOW PRESS.	* HIGH PRESS.								* LOW PRESS.	* HIGH PRESS.						
MR 33	124	--	65	--	26,2	--	69,4	235,4	160	180	125	-	120	-	M10-25	G 1/4	9	97	--	--	25	--	
MR 57																							
MR 73	120	50	--	--	100	90	--	250	204	224,4	145	-	129	M8-15	--	G 3/8	11	-	20	--	--	--	
MR 93																							
MR 110																							
MR 125	120	50	--	--	100	100	--	313,2	225	249	160	-	129	M8-15	--	G 3/8	11	160	20	--	--	--	
MR 160																							
MR 190																							
MR 200	120	50	--	--	100	100	--	328	232	256	175	90	129	M8-15	--	G 3/8	11	162	20	--	--	--	
MR 250																							
MR 300																							
MRE 330																							
MR 350	142	60	--	--	120	119	--	368	266	296	190	96	156	M10-18	--	G 3/8	13	194	25	--	--	--	
MR 450																							
MRE 500																							
MR 600	142	60	--	--	120	133	--	405	290	320	220	102	156	M10-18	-	G 3/8	13	207	25	-	-	-	
MR 700																							
MRE 800																							
MR 1100	162	73	--	--	136	148	--	470	330	367	250	120	172	M12-21	--	G 1/2	15	228	31	--	--	--	
MR 1600																							
MR 1800	162	73	--	--	136	168	--	558	380	423	290	148	172	M12-21	--	G 1/2	17	266	31	--	--	--	
MRE 2100																							
MR 2400	233	86	86	101	180	190	35,7	642	440	494	335	140	215	M14-28	M12-30	M16-35	G 1/2	19	314	37	37	37	
MRE 3100																							
MR 3600	233	116	116	116	200	240	42,88	766	540	597	400	-	215	M16-28	M12-30	M20-34	G 1/2	23	380	38	50	50	
MR 4500																							
MRE 5400																							
MR 6500	233	116	116	116	200	264	42,88	864	600	658,6	450	190	215	M16-28	M12-30	M20-34	G 1/2	25	450	38	50	50	
MR 7000																							
MRE 8200																							

\* FOR PRESSURE VALUES PLEASE REFER TO PAG.42 "SAE CONNECTION FLANGES". "SAE PSI" VALUES. -- ALSO AVAILABLE UNC. THREAD, PLEASE CONSULT PARKER CALZONI

Code D 1 - DIN 5480

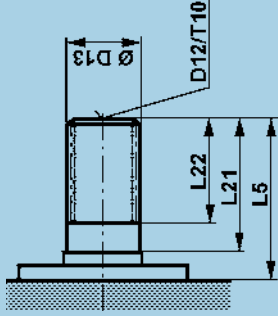

Code B 1 - BS 3550 - 1)

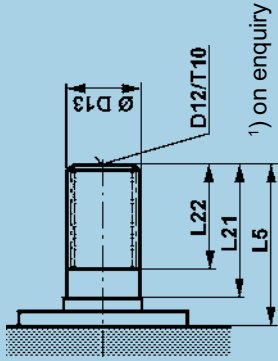

Code N 1 (Standard)

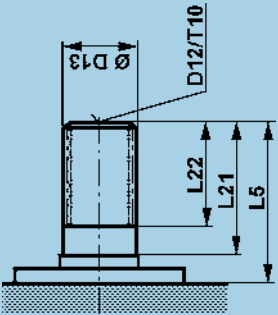

Version	N1						B1						D1					
	L5	L21	L22	D12	T10	ØD13	L5	L21	L22	D12	T10	ØD13	L5	L21	L22	D12	T10	ØD13
MR 33	57	40	28	-	-	B6x26x32	-	-	-	-	-	-	57	40	28	-	-	W32x1,5x20-8e
MR 57																		
MR 73	68,5	44,8	31,5	M12	-	B6x28x34	-	-	-	-	-	-	68,5	51,5	31,5	M12	-	W35x2x16-8e
MR 93																		
MR 110																		
MR 125	67	50	35,5	M12	20	B8x32x38	67	50	35,5	M12	20	12/24-17	67	50	35,5	M12	20	W38x2x18-8e
MR 160																		
MR 190																		
MR 200 *	-	-	-	-	-	-	-	-	-	-	-	-	-	-	-	-	-	-
MR 250	81	60	46	M12	25	B8x42x48	81	60	45	M12	25	12/24-21	81	60	46	M12	25	W48x2x22-8e
MR 300																		
MRE 330																		
MR 350	97	74	56,5	M12	25	B8x46x54	97	74	61	M12	25	8/16-17	97	74	60	M12	25	W55x3x17-8e
MR 450																		
MRE 500																		
MR 600	101	78	62	M12	25	B8x52x60	101	78	62	M12	25	8/16-17	101	78	62	M12	25	W60x3x18-8e
MR 700																		
MRE 800																		
MR 1100	117	88	69	M12	25	B8x62x72	117	88	67	M12	25	6/12-14	117	88	72	M12	25	W70x3x22-8e
MRE 1400																		
MR 1600	132	100	79	M12	25	B10x72x82	132	100	76	M12	25	6/12-20	132	100	80	M12	25	W80x3x25-8e
MR 1800																		
MRE 2100																		
MR 2400	153	120	99	M12	25	B10x82x92	153	120	76	M12	25	6/12-20	153	120	100	M12	25	W90x4x21-8e
MR 2800																		
MRE 3100																		
MR 3600	210	173	144	M12	25	B10x102x112	210	173	142,5	M12	25	6/12-20	210	173	144	M12	25	W110x4x26-8e
MR 4500																		
MRE 5400																		
MR 6500	230	188	150	M12	25	B10x112x125	230	188	153	M12	25	6/12-26	230	188	153	M12	25	W120x4x28-8e
MR 7000																		
MRE 8200																		

NOTE: the threaded holes (D12/T10) for the shaft versions "N1", "B1" and "D1" must be considered as service holes. In case the holes dimensions required by the application are different from the ones listed here above, please contact PARKER Calzoni.  
MR\_200 \* only code "F1"

Code F 1 - DIN 5480 -

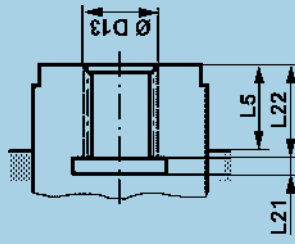

Code P 1

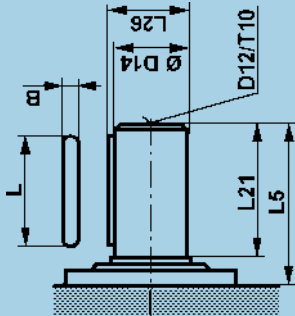

Code P 1 \*\*

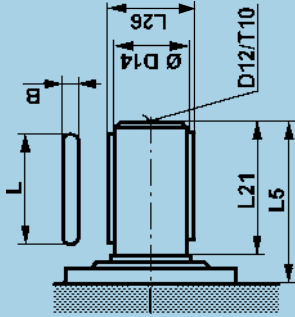

Only MR 6500, MR 7000,  
MRE 8200

Version Type	F1					P1					Transmitted torque (Nm)	
	L5	L21	L22	ØD13 DIN 5480	L5	L21	L26	D12	T10	ØD14		Key L x B
MR 33	17	5	21	N28x1,25x21-9H	-	-	-	-	-	-	-	-
MR 57	17	5	26	N32x2x14-9H	-	-	-	-	-	-	-	-
MR 73	14	5	28	N35x2x16-9H	67	50	43	M12	20	40 k6	45 x 12	496
MR 93	14	5	28	N40x2x18-9H	-	-	-	-	-	-	-	-
MR 110	27	5	36	N40x2x18-9H	-	-	-	-	-	-	-	-
MR 125	27	5	36	N40x2x18-9H	81	60	53,5	M12	25	50 k6	56 x 14	897
MR 160	28	5	38	N47x2x22-9H	97	74	59	M12	25	55 k6	70 x 16	1413
MR 190	28	5	44	N55x3x17-9H	101	78	64	M12	25	60 k6	70 x 18	2030
MR 200 *	38	8	50	N65x3x20-9H	117	88	76,5	M12	25	70 k6	80 x 20	2690
MR 250	47	8	57	N75x3x24-9H	132	100	85	M12	25	80 k6	90 x 22	4020
MR 300	48	8	62	N85x3x27-9H	153	120	95	M12	25	90 k6	110 x 25	6207
MRE330	50	14	68	N100x3x32-9H	210	173	116	M12	25	110 k6	160 x 28	10757
MR 350	50	14	76	N110x3x35-9H	230	188	138	M12	25	124 b8	N°2-180 x 32	28270
MR 450	50	14	76	N110x3x35-9H	230	188	138	M12	25	124 b8	N°2-180 x 32	28270
MRE 500	50	14	76	N110x3x35-9H	230	188	138	M12	25	124 b8	N°2-180 x 32	28270
MR 600	50	14	76	N110x3x35-9H	230	188	138	M12	25	124 b8	N°2-180 x 32	28270
MR 700	50	14	76	N110x3x35-9H	230	188	138	M12	25	124 b8	N°2-180 x 32	28270
MRE 800	50	14	76	N110x3x35-9H	230	188	138	M12	25	124 b8	N°2-180 x 32	28270
MR 1100	50	14	76	N110x3x35-9H	230	188	138	M12	25	124 b8	N°2-180 x 32	28270
MR 1400	50	14	76	N110x3x35-9H	230	188	138	M12	25	124 b8	N°2-180 x 32	28270
MR 1600	50	14	76	N110x3x35-9H	230	188	138	M12	25	124 b8	N°2-180 x 32	28270
MR 1800	50	14	76	N110x3x35-9H	230	188	138	M12	25	124 b8	N°2-180 x 32	28270
MRE 2100	50	14	76	N110x3x35-9H	230	188	138	M12	25	124 b8	N°2-180 x 32	28270
MR 2400	50	14	76	N110x3x35-9H	230	188	138	M12	25	124 b8	N°2-180 x 32	28270
MR 2800	50	14	76	N110x3x35-9H	230	188	138	M12	25	124 b8	N°2-180 x 32	28270
MRE 3100	50	14	76	N110x3x35-9H	230	188	138	M12	25	124 b8	N°2-180 x 32	28270
MR 3600	50	14	76	N110x3x35-9H	230	188	138	M12	25	124 b8	N°2-180 x 32	28270
MR 4500	50	14	76	N110x3x35-9H	230	188	138	M12	25	124 b8	N°2-180 x 32	28270
MRE 5400	50	14	76	N110x3x35-9H	230	188	138	M12	25	124 b8	N°2-180 x 32	28270
MR 6500	50	14	76	N110x3x35-9H	230	188	138	M12	25	124 b8	N°2-180 x 32	28270
MR 7000	50	14	76	N110x3x35-9H	230	188	138	M12	25	124 b8	N°2-180 x 32	28270
MRE 8200	50	14	76	N110x3x35-9H	230	188	138	M12	25	124 b8	N°2-180 x 32	28270

**NOTE**  
For higher values of the torque to be transmitted, please consult **PARKER Calzoni**

NOTE: the threaded holes (D12/T10) for the shaft versions "P1" must be considered as service holes. In case the holes dimensions required by the application are different from the ones listed here above, please contact PARKER Calzoni.  
MR 200 \* only code "F1"  
\*\*This dimension includes two keys

**MECHANICAL  
TACHOMETER DRIVE**

**TACHOGENERATOR  
DRIVE**

**ENCODER  
DRIVE**

Code "C1"

Code "T1"

Code "Q1"

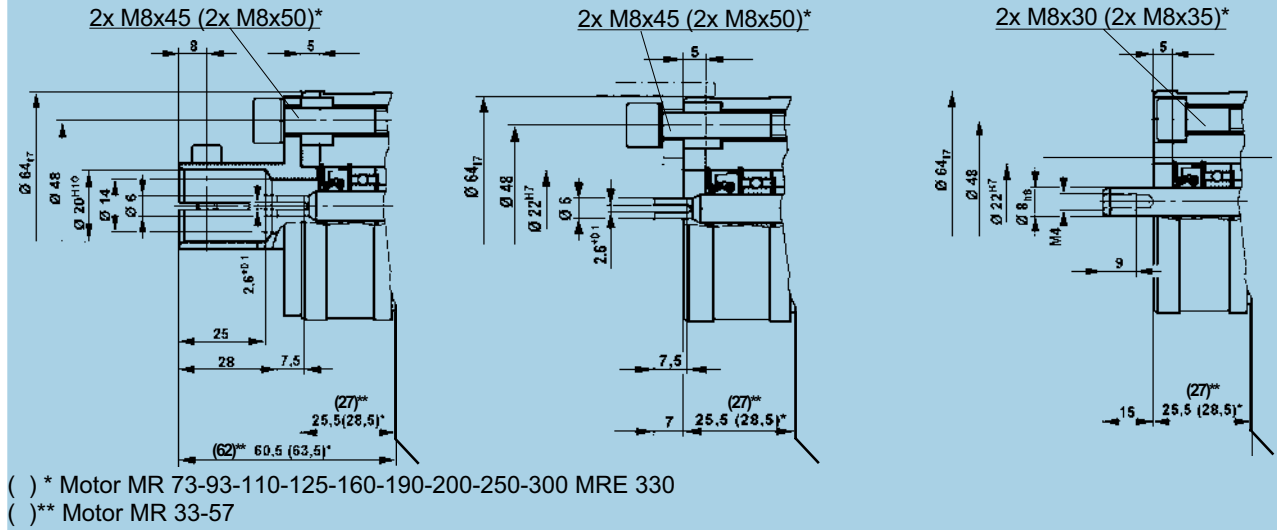

**INCREMENTAL ENCODER  
DIMENSIONS**

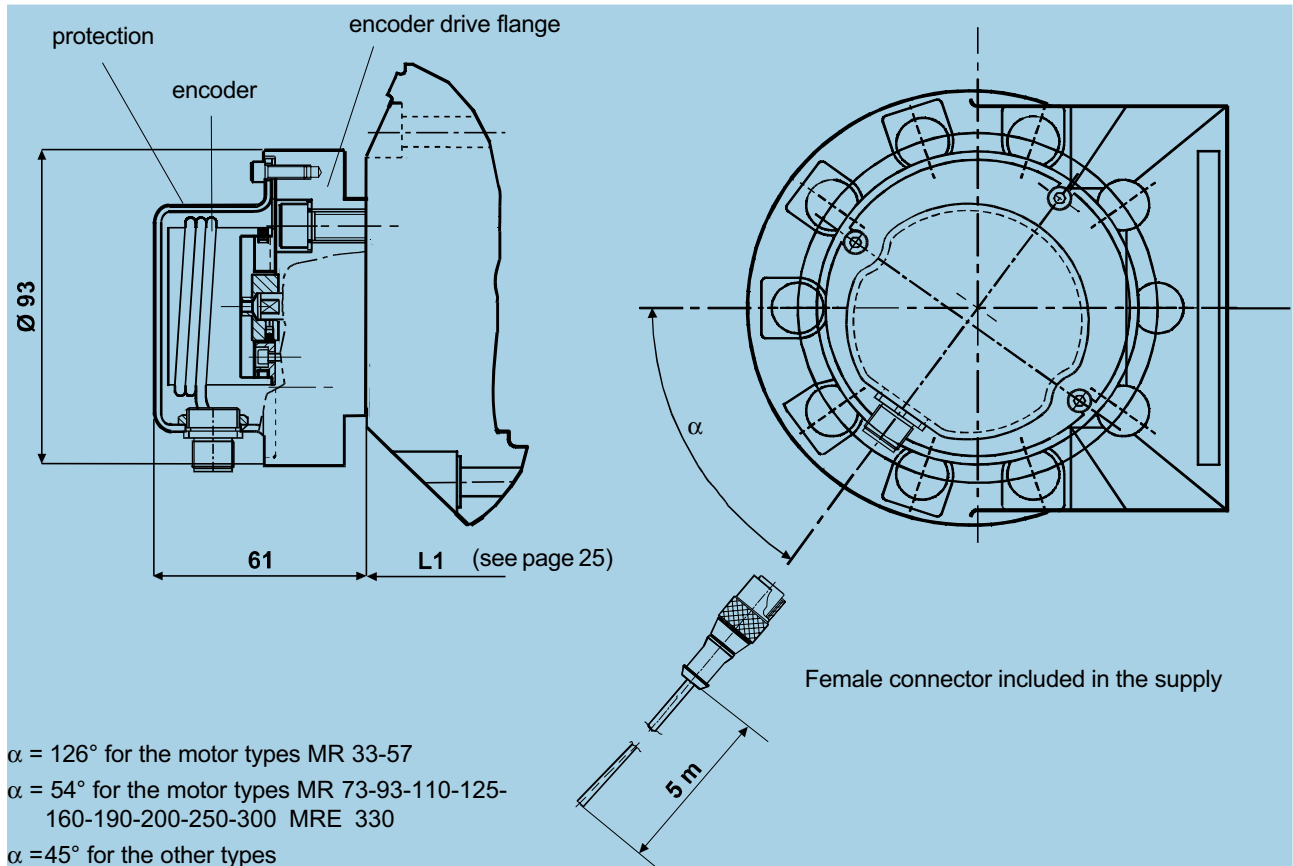

**INCREMENTAL ENCODER  
CONNECTION DIAGRAMS**

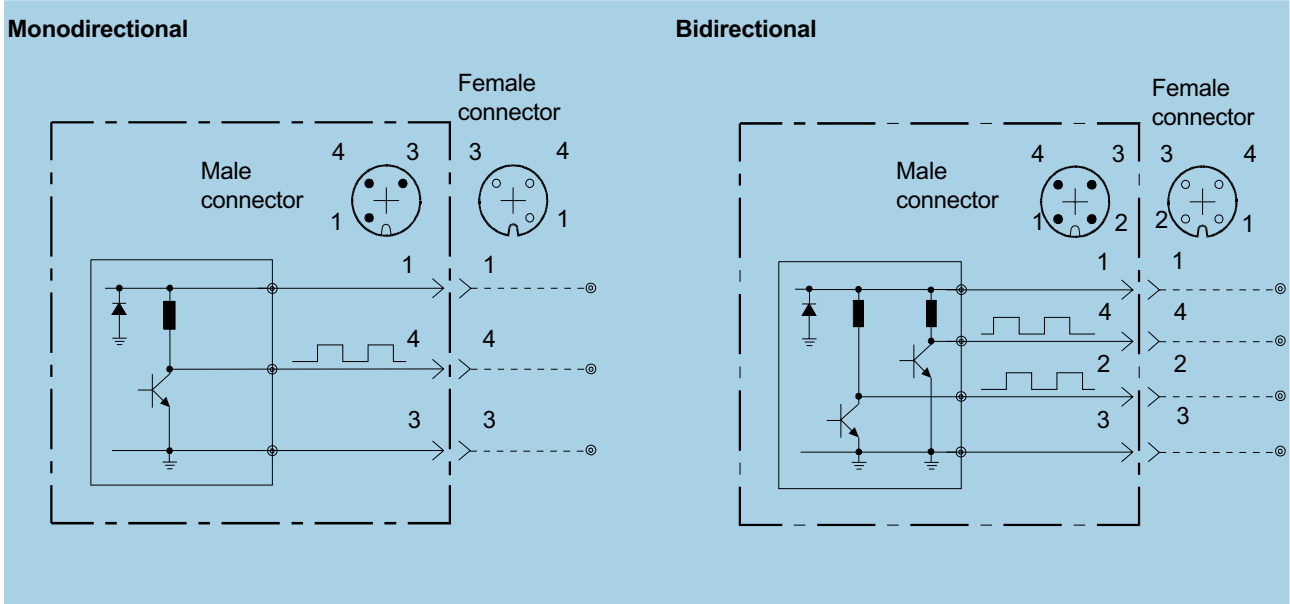

Color wires and function		
<b>1</b>	<b>Brown</b>	Power Supply (8 to 24 Vdc)
<b>2</b>	<b>White</b>	Output B phase (MAX 10 mA - 24 Vcc)
<b>3</b>	<b>Blue</b>	Power Supply (0 Vdc)
<b>4</b>	<b>Black</b>	Output A phase (MAX 10 mA - 24 Vcc)

**INCREMENTAL ENCODER  
TECHNICAL DATA**

Encoder type:	ELCIS mod. 478
Supply voltage:	8 to 24 Vcc
Current consumption:	120 mA max
Current output:	10 mA max
Output signal:	A phase- MONODIRECTIONAL A and B phase BIDIRECTIONAL
Response frequency:	100 KHz max
Number of pulses:	500 (others on request - max 2540)
Slew speed:	Always compatible with maximum motor speed
Operating temperature range:	from 0 to 70 °C
Storage temperature range:	from -30 to +85 °C
Ball bearing life:	1.5x10 <sup>9</sup> rpm
Weighth:	100 gr
Protection degree:	IP 67 (with protection and connector assembled)

Connectors:		
MONODIRECTIONAL	RSF3/0.5 M (Lumberg)	male
	RKT3-06/5m (Lumberg)	female
BIDIRECTIONAL	RSF4/0.5 M (Lumberg)	male
	RKT4-07/5m (Lumberg)	female

Note: Female connectors cable length equal to 5 m.



**STANDARD CONNECTION FLANGE**

Code "C1"

Flange is supplied complete with screws and seals.

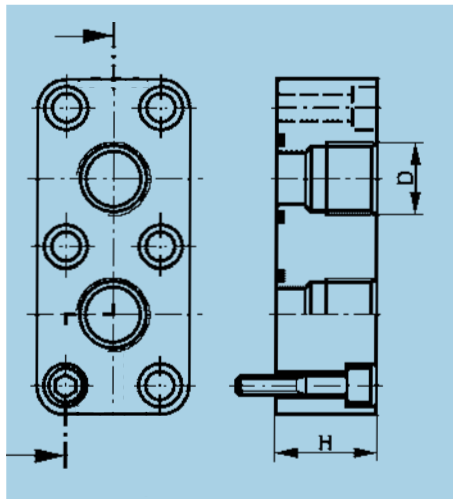

MR MRE	D (BSP)	H	ORDERING CODE NBR	ORDERING CODE FPM
<b>73 - 93 - 110</b> 125 - 160 - 190 200 - 250 300 - 330	3/4"	38	262 098	229 394
<b>350 - 450</b> 500 600 - 700 800	1 1/4"	39	262 089	229 395
<b>1100 - 1400</b> 1600 - 1800 2100	1 1/2"	45	262 093	229 396
<b>2400 - 2800</b> 3100	1 1/2"	59	264 572	229 397
<b>3600 - 4500</b> 5400 6500 - 7000 8200	2"	58	272 724	229 398

BSP threads to ISO 228/1

Permitted up to 6000 PSI

**SAE CONNECTION FLANGE**

Codice "S1"

Codice "T1"

Codice "G1"

Codice "L1"

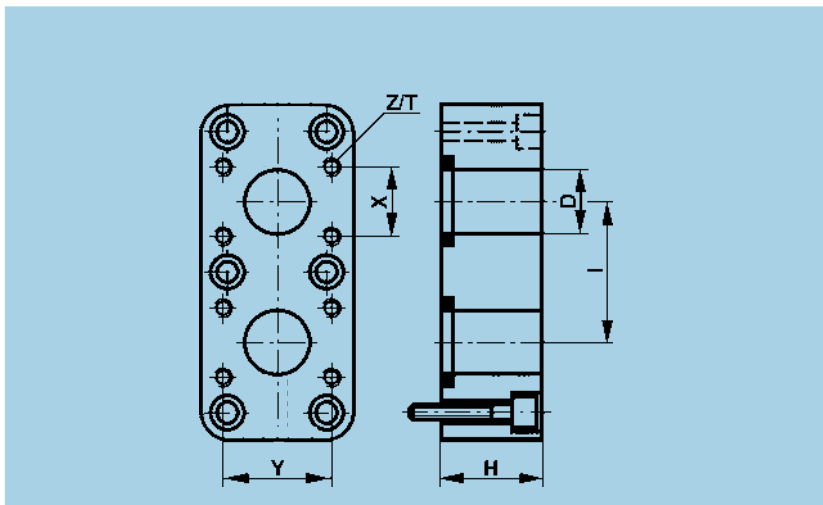

Flange is supplied complete with screws and seals. FPM seals enquiry.

MR MRE	SAE PSI	D		H	I	X	Y	METRIC		UNC		
		"	mm					Z / T	ORDERING CODE NBR	Z (")	T	ORDERING NBR
<b>73 - 93 - 110</b> 125 - 160 - 190 200 - 250 300 - 330	5000	3/4"	19	38	55	22,2	47,6	M10/25	277 295	3/8"- 16	25	223 335
<b>350 - 450</b> 500 600 - 700 800	5000	1"	25	39	60	26,2	52,4	M10/25	277 297	3/8"- 16	25	223 336
<b>1100 - 1400</b> 1800 - 1600 2100	4000	1 1/4"	31	45	75	30,2	58,7	M10/25	277 299	7/16"- 14	30	223 337
	6000	1"	25	45	71	27,8	57,15	M12/22	230 166	7/16"- 14	30	342 092
<b>2400 - 2800</b> 3100	3000	1 1/2"	37	59	86	35,7	69,8	M12/30	277 301	1/2"- 13	30	223 338
	6000	1 1/2"	37	59	100	36,5	79,4	M16/30	230 168	5/8"- 11	35	349068
<b>3600 - 4500</b> 5400 6500 - 7000 8200	3000	2"	50	58	112	42,9	77,8	M12/30	277 303	1/2"- 13	30	223 339
	6000	2"	50	58	116	44,45	96,82	M20/35	230 170	3/4"- 10	38	342 547

COUPLINGS

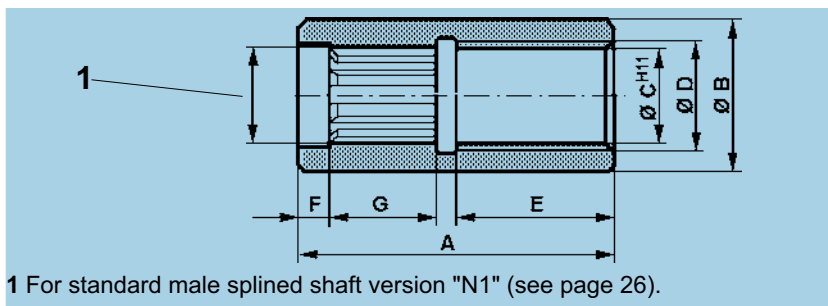

MR MRE	ORDERING CODE	A	B	C <sup>H11</sup>	D	E	F	G
125 - 160 190	465 203	114	56	39	47	54	15,5	34,5
250 - 300 330	465 202	135	71	49	60	64	15	45
350 - 450 500	465 201	155	80	55	68	68	18,5	55,5
600 - 700 800	465 200	171	90	61	75	80	19	59
1100 1400	464 785	186	106	73	88,5	85,5	20	65,5
1600 - 1800 2100	465199	224	118	83	98	107	22	78
2400 - 2800 3100	465 198	265	132	93	112	127	23	97
3600 - 4500 5400	474 692	355	150	113	126	165	30	140
6500 - 7000 8200	422 544	390	195	126	140	185	38	147

ADAPTERS WITH KEY

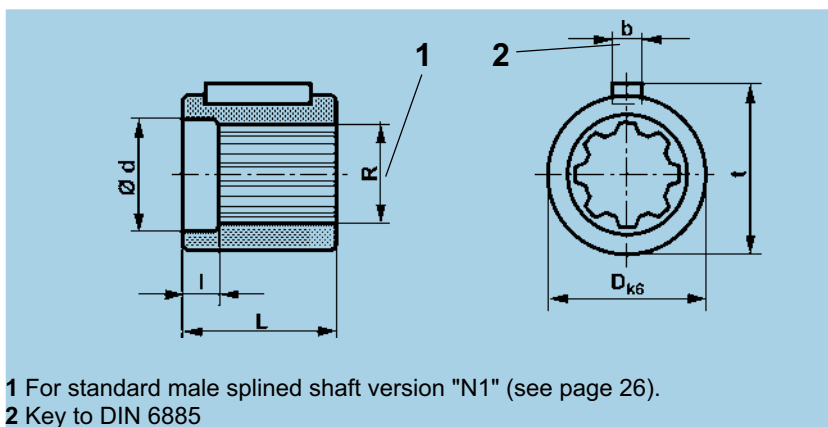

MR MRE	ORDERING CODE	R EX DIN 5463 (mm)	d	l	D <sub>k6</sub>	L	b	t	Key (mm) DIN 6885
125 - 160 190	271 117	A8x32x38	38,3	15,5	58	50	10	61	10x8x45
250 - 300 330	271 118	A8x42x48	48,3	15	70	60	14	73,5	14x9x56
350 - 450 500	271 119	A8x46x54	54,3	18,5	80	75	16	84	16x10x70
600 - 700 800	271 120	A8x52x60	60,3	19	90	80	18	94	18x11x70
1100 - 1400	271 121	A8x62x72	72,3	20	105	98	20	109,5	20x12x90
1600 - 1800 2100	271 122	A10x72x82	82,3	22	118	118	22	123	22x14x110
2400 - 2800 3100	271 123	A10x82x92	92,3	29	130	148	25	135	25x14x140
3600 - 4500 5400	272 719	A10x102x112	112,3	30	160	188	28	166	28x16x180
6500 - 7000 8200	223 476	A10x112x125	125,6	38	185	188	45	195	45x25x180

## HOLDING BRAKE UNIT DIMENSIONS - MOTOR TYPE MR - MRE

BRAKE TYPE	B 190	B 300	B 450	B 700	B 1100	B 1800	B 2800
MOTOR TYPE MR - MRE	125 - 160 190	250 - 300 330	350 - 450 500	600 - 700 800	1100 - 1400	1600 - 1800 2100	2400 - 2800 3100

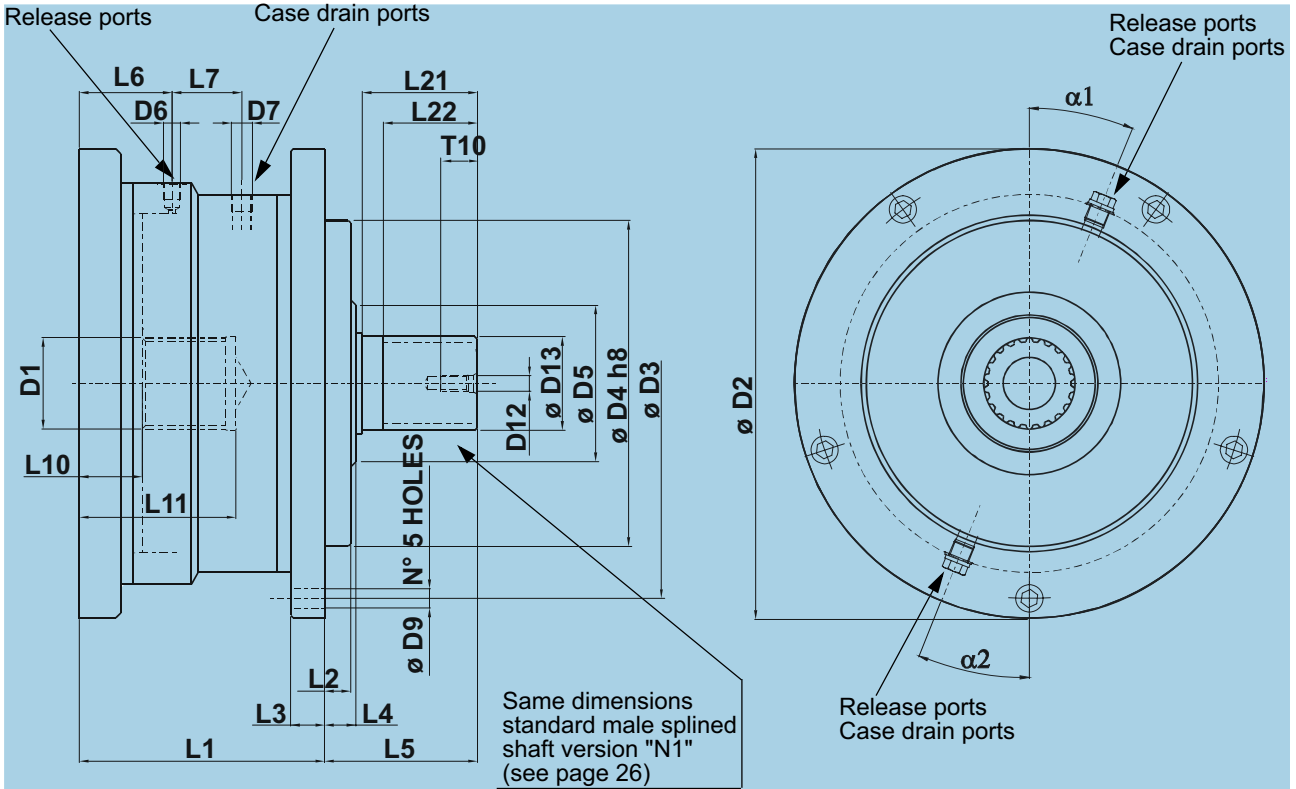

$\alpha 1, \alpha 2$  Corresponding angles to the release ports 1 and 2, to case the drain ports 1 and 2

BRAKE TYPE	L1	L2	L3	L4	L5	L6	L7	L10	L11	L21	L22	D1	D2	D3	D4 <sub>h8</sub>	D5	D6	D7	D9	D12	D13	T10	$\alpha 1$	$\alpha 2$
B 190	121	-	22	14	67	41	29,3	20	72	50	35,5	see page 26 compatible code N1 D1	250	225	160	-	G1/4"	G3/8"	10,5	M12	see page 26-27 code N1- D1- F1	28	22°30'	22°30'
B 300	136	-	25	15	81	42	39,5	21	86	60	46		256	232	175	-	G1/4"	G3/8"	10,5	M12		28	22°30'	22°30'
B 450	147	-	27	15	97	49,5	36	24	100	74	56,5		296	266	190	-	G1/4"	G3/8"	13,5	M12		28	22°30'	22°30'
B 700	172	-	28	15	101	55	46	25	105	78	62		320	290	220	-	G1/4"	G3/8"	13,5	M12		28	22°30'	22°30'
B 1100	188	20	26	24	117	71	53,5	48	120	88	72		360	330	250	120	G1/4"	G1/2"	15	M12		28	0°	0°
B 1800	216	-	28	21	132	63,5	58,5	34	135	100	79		423	380	290	-	G1/4"	G1/2"	17,5	M12		28	22°30'	22°30'
B 2800	263	-	30	24	153	87	67	42,5	165	120	99		494	440	335	-	G1/4"	G1/2"	19	M12		28	22°30'	22°30'

TECHNICAL DATA

(For operation outside these parameters, please consult **PARKER Calzoni**)

CHARACTERISTICS		BRAKE TYPE						
		B 190	B 300	B 450	B 700	B 1100	B 1800	B 2800
STATIC BRAKING TORQUE	Nm	1250	1800	2650	4000	6200	11400	17100
DYNAMIC BRAKING TORQUE	Nm	870	1200	1450	2200	4200	6250	12000
RELEASE PRESSURE	bar	28	28	27	27	27	30	30
MAX. OPERATING PRESSURE	bar	420	420	420	420	420	420	420
MOMENT OF INERTIA OF ROTATING PARTS	Kgm <sup>2</sup>	0,0047	0,0062	0,029	0,043	0,061	0,20	0,27
WEIGHT	Kg	32	39	54	74	100	158	262
MOTOR TYPE MR MRE		125 160 190	250 300 330	350 450 500	600 700 800	1100 1400	1600 1800 2100	2400 2800 3100

CODE

Example: BRAKE - B 450 N1 N1 V1 \*\*

1. BRAKE - B 450 N1 N1 V1 \*\*

BRAKE TYPE

<b>B 190</b>	Brake for motor size "C"
<b>B 300</b>	Brake for motor size "D"
<b>B 450</b>	Brake for motor size "E"
<b>B 700</b>	Brake for motor size "F"
<b>B 1100</b>	Brake for motor size "G"
<b>B 1800</b>	Brake for motor size "H"
<b>B 2800</b>	Brake for motor size "I"

2. BRAKE - B 450 N1 N1 V1 \*\*

OUTPUT SHAFT

<b>N1</b>	Spline ex DIN 5463 (see page 26)
<b>D1 *</b>	Spline DIN 5480 (see page 26)
<b>F1 *</b>	Female spline DIN 5480 (see page 27)
<b>* please contact PARKER Calzoni</b>	

3. BRAKE - B 450 N1 N1 V1 \*\*

INPUT SHAFT

<b>N1</b>	Hollow shaft for motor type N1 (see page 26)
<b>D1</b>	Hollow shaft for motor type D1 (see page 26)

4. BRAKE - B 450 N1 N1 V1 \*\*

SEALS

<b>N1</b>	NBR: mineral oil
<b>V1 *</b>	FPM seals
<b>U1</b>	No shaft seal (for brake)
<b>* please contact PARKER Calzoni</b>	

5. BRAKE - B 450 N1 N1 V1 \*\*

SPECIAL

<b>**</b>	Space reserved to PARKER Calzoni
-----------	----------------------------------

**Mounting**

Any mounting position

- Note the position of the case drain port (see below)

Install the motor properly

- Mounting surface must be flat and resistant to bending

Min. tensile strength of mounting screws to DIN 267 Part 3 class 10.9

- Note the prescribed fastening torque

**Pipes, pipe connections**

Use suitable screws!

- Depending on type of motor use either threaded or flange connection

Choose pipes and hoses suitable for the installation

- Please note manufacturing data!

Before operation fill with hydraulic fluid

- Use the prescribed filter!

**NOTE:** Two of the mounting screws must be precisely located/fitted if operation is started and stopped frequently or if high reversible frequencies exist.

**Coupling**

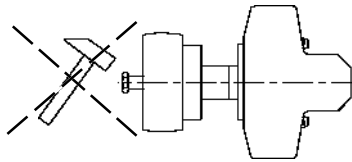

- Mounting with screws
- Use threaded bore in the drive shaft
- Take apart with extractor

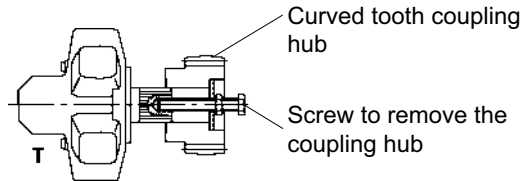

Curved tooth coupling hub

Screw to remove the coupling hub

**DRAIN AND FLUSHING LINK INSTALLATION EXAMPLES**

**Note:** Position the case drain pipe, so that the motor **cannot run empty**.

T = Seal  
 Y = Motor housing feeding line  
 ← = Bleed

**Installation instructions for motors of the series "MR - MRE"**

Low pressure case drain returns to tank.

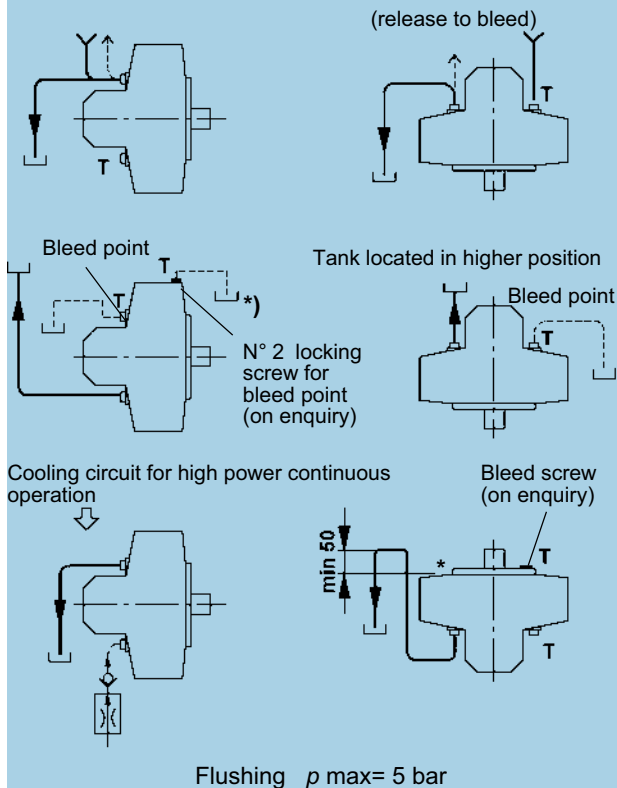

\*) Special designs for applications, where the equipment needs to be filled with oil.(e.g. in a salty atmosphere)

**Installation instructions for motors of the series "MR - MRE with brakes"**

Low pressure case drain returns to tank.

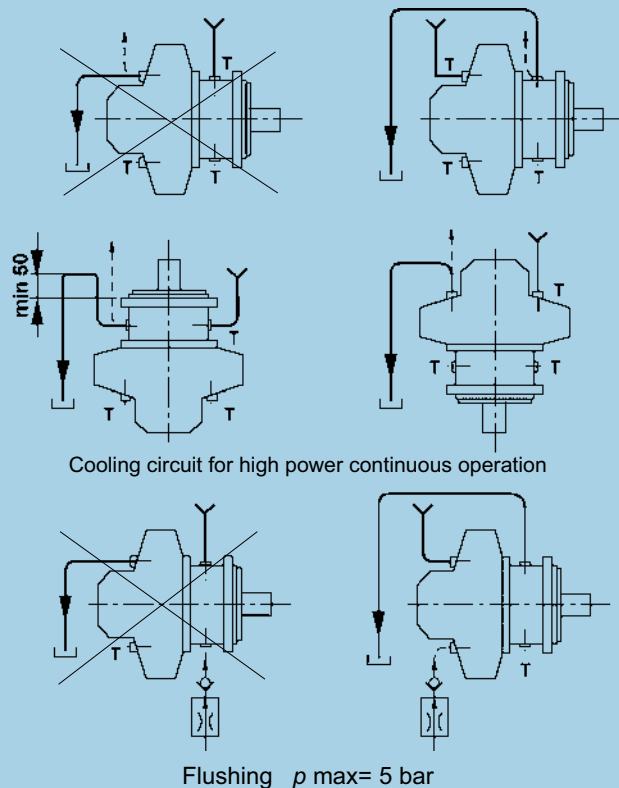

Motors without shaft seal used with brake

**CODE**

Example: MR 160C - N1 M1 F1 N1 N \*\*

1. MR 160C - N1 M1 F1 N1 N \*\*  
**SERIES**

<b>MR</b>	standard 250 bar max. continuous
<b>MRE</b>	expanded 210 bar max. continuous

2. MR 160C - N1 M1 F1 N1 N \*\*

**SIZE & DISPLACEMENT**

<b>A</b>	code	<b>MR 33 A</b>	<b>MR 57 A</b>		
	Cm <sup>3</sup>	32,1	56,4		
<b>B</b>	code	<b>MR 73 B</b>	<b>MR 93 B</b>	<b>MR110 B</b>	
	Cm <sup>3</sup>	72,6	92,6	109,0	
<b>C</b>	code	<b>MR 125 C</b>	<b>MR 160 C</b>	<b>MR 190 C</b>	
	Cm <sup>3</sup>	124,7	159,7	191,6	
<b>D</b>	code	<b>MR 200 D</b>	<b>MR 250 D</b>	<b>MR 300 D</b>	<b>MRE 330 D</b>
	Cm <sup>3</sup>	199,2	250,9	304,1	332,4
<b>E</b>	code	<b>MR 350 E</b>	<b>MR 450 E</b>	<b>MRE 500 E</b>	
	Cm <sup>3</sup>	349,5	451,6	497,9	
<b>F</b>	code	<b>MR 600 F</b>	<b>MR 700 F</b>	<b>MRE 800 F</b>	
	Cm <sup>3</sup>	607,9	706,9	804,2	
<b>G</b>	code	<b>MR 1100 G</b>	<b>MRE 1400 G</b>		
	Cm <sup>3</sup>	1125,8	1369,5		
<b>H</b>	code	<b>MR 1600 H</b>	<b>MR 1800 H</b>	<b>MRE 2100 H</b>	
	Cm <sup>3</sup>	1598,4	1809,6	2091,2	
<b>I</b>	code	<b>MR 2400 I</b>	<b>MR 2800 I</b>	<b>MRE 3100 I</b>	
	Cm <sup>3</sup>	2393,0	2792,0	3103,7	
<b>L</b>	code	<b>MR 3600 L</b>	<b>MR 4500 L</b>	<b>MRE 5400 L</b>	
	Cm <sup>3</sup>	3636,8	4502,7	5401,2	
<b>M</b>	code	<b>MR 6500 M</b>	<b>MR 7000 M</b>	<b>MRE 8200 M</b>	
	Cm <sup>3</sup>	6460,5	6967,2	8226,4	

3. MR 160C - N1 M1 F1 N1 N \*\*

**SHAFT**

<b>N1</b>	spline ex DIN 5463 (see page 26)
<b>D1</b>	spline DIN 5480 ((see page 26)
<b>F1</b>	female spline DIN 5480 (see page 27)
<b>P1</b>	shaft with key (see page 27)
<b>B1</b>	spline B.S. 3550 (see page 26)

4. MR 160C - N1 M1 F1 N1 N \*\*

**SPEED SENSOR OPTION**

<b>N1</b>	none	
<b>Q1</b>	encoder drive (see page 28)	
<b>C1</b>	mechanical tachometer drive (see page 28)	
<b>T1</b>	tachogenerator drive (see page 28)	
<b>M1</b>	incremental Elcis encoder	Uni-directional
<b>B1</b>	( 500 pulse/rev) (see page 28)	Bi-directional

5. MR 160C - N1 M1 F1 N1 N \*\*

**SEALS**

<b>N1</b>	NBR mineral oil
<b>F1</b>	NBR, 15 bar shaft seal
<b>V1</b>	FPM seals
<b>U1</b>	no shaft seal (for brake)

6. MR 160C - N1 M1 F1 N1 N \*\*

**CONNECTION FLANGE**

<b>N1</b>	none (MR 33 - MR57 see page 24)
<b>C1</b>	standard PARKER Calzoni (see page 30)
<b>S1</b>	standard SAE metric (see page 30)
<b>T1</b>	standard SAE UNC (see page 30)
<b>G1</b>	SAE 6000 psi metric (see page 30)
<b>L1</b>	SAE 6000 psi UNC (see page 30)
<b>S3</b>	standard SAE metric motor integrated (see page 25)
<b>G3</b>	SAE 6000 psi metric motor integrated (see page 25)

7. MR 160C - N1 M1 F1 N1 N \*\*  
**ROTATION**

<b>N</b>	standard rotation (CW: inlet in A, CCW: inlet in B)
<b>S</b>	reversed rotation (CW: inlet in B, CCW: inlet in A)

8. MR 160C - N1 M1 F1 N1 N \*\*  
**SPECIAL**

<b>**</b>	space reserved to PARKER Calzoni
-----------	----------------------------------



FOR INFORMATION ABOUT SALES AND SERVICE LOCATIONS PLEASE CONTACT:

**Parker Calzoni S.r.l.**  
Via caduti di sabbiano 15/17  
40011 Anzola dell'Emilia  
Bologna – Italy  
Tel. +39.051.6501611  
Fax. +39.051.736221  
e-mail: [infocalzoni@parker.com](mailto:infocalzoni@parker.com)

[www.parker.com](http://www.parker.com)



YOUR LOCAL **PARKER CALZONI** REPRESENTATIVE

**CALZONI**